

# Tylösand T-870

2021-12-03

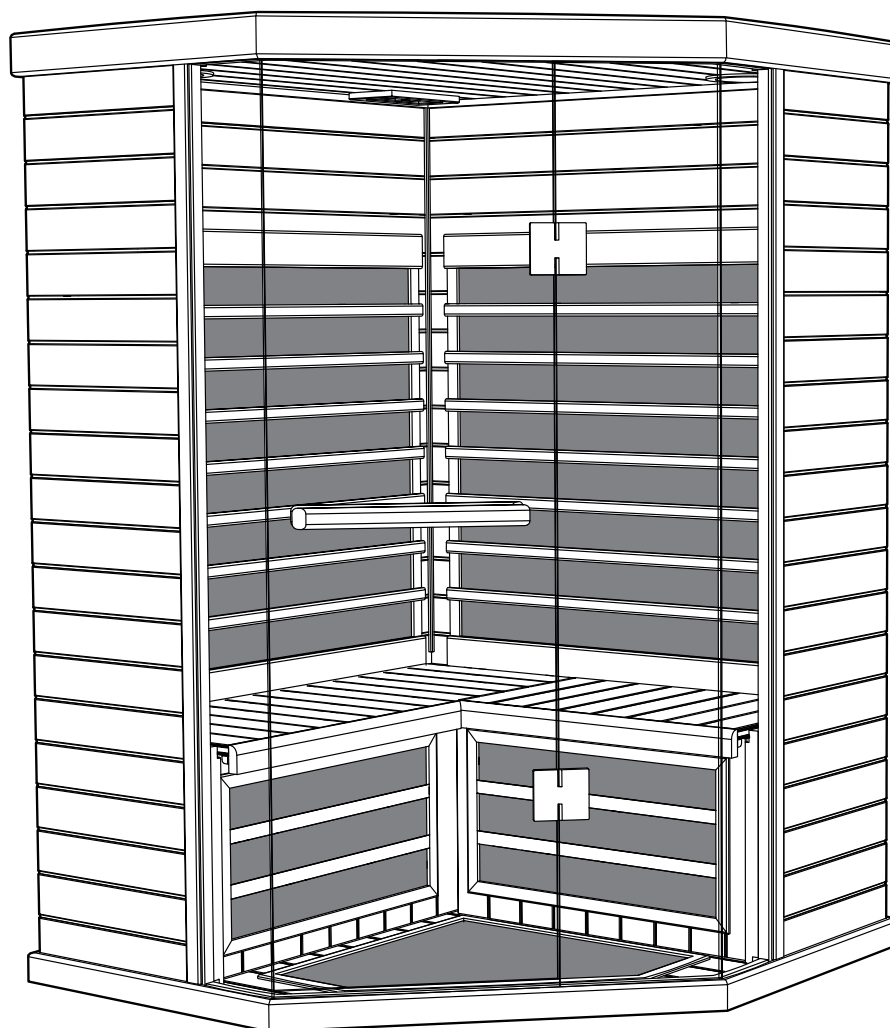

SVENSKA

**INSTALLATION-/BRUKSANVISNING**

ENGLISH

**INSTALLATION/USER GUIDE**

DEUTSCH

**INSTALLATIONS-/BEDIENUNGSANLEITUNG**

FRANÇAIS

**INSTALLATION/MODE D'EMPLOI**

РУССКИЙ

**РУКОВОДСТВО ПО УСТАНОВКЕ/ЭКСПЛУАТАЦИИ**

NEDERLANDS

**INSTALLATIE-/GEBRUIKERSHANDLEIDING**

POLSKI

**INSTRUKCJA INSTALACJI/OBSŁUGI**

**TYLÖ**<sup>®</sup>

Tylösand T-870 - 3 person infrared sauna

Table of contents

Precautions before Use .....15

Pre-assembly Information: .....15

Electrical Requirements: .....15

Sauna Assembly Instructions .....15

Electrical Connections under bench .....18

Electrical Connections inside the Ceiling .....21

How to Use Infrared Sauna:.....22

Tips & Troubleshooting: .....23

Wiring diagram: .....23

IR2 Control Operation .....24

Operating Instructions for Lighting .....24

Audio operation .....24

SaunaLogic App Quick Start Guide .....25

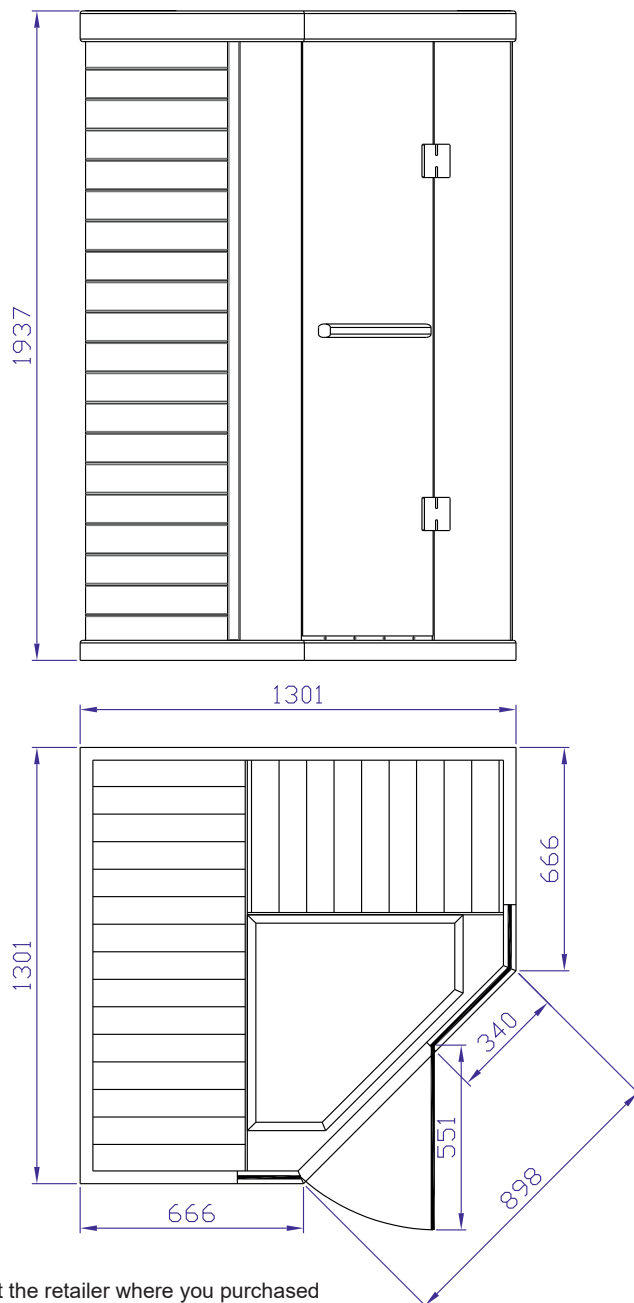

Please keep these instructions!  
 In the event of problems, please contact the retailer where you purchased the equipment.  
 © This publication may not be reproduced, in part or in whole, without the written permission of Tylö. Tylö reserves the right to make changes to materials, construction and design.

**Precautions before Use**

**Note: Room must be installed on flat, level surface.**

- Proper Electrical Grounding is Required
- Electrical Receptacles not Allowed in the Room
- Do not Apply Water to any Heating Element
- Do not Add a Locking or Latching System to the Door
- Do not Block Ventilation Openings
- Children Must be Supervised at all Times in the Sauna

**Electrical Caution – Do not plug the room power cord into an electrical outlet until Room Assembly is completed!**

**a. Warning (Human Limitations):**

Prolonged Exposure at Elevated Temperatures May Cause Hyperthermia (Body Temperature is Several Degrees Above 37°C (98.6F))

Hyperthermia Symptoms include: Dizziness, Lethargy, Drowsiness, and Fainting.

Hyperthermia can cause:

- Fetal Damage in Pregnant Women
- Physical In-Ability to Exit the Room
- Loss of Consciousness

Notice - Use of Alcohol or Drugs Increases the Risk of Fatal Hyperthermia

If You Have any Health Problems or Health Conditions, Consult Your Physician Prior to Sauna Use, Discontinue Use if Nervousness, Tremor, Headache, Feeling of Sickness or Nausea Occurs.

**b. Warning (Fire Hazards):**

Do Not Use the Sauna Room for Drying Cloths, Bathing Suits, Etc.

Do Not Hang Towels or Other Objects on Heater Grills.

Never Operate this Sauna Room if it Has a Damaged Cord or Plug.

**Pre-assembly Information:**

- Two (2) adults are required for the assembly and installation of the room.
- Assembly Tools: Phillips Screw Driver
- Boxes are labeled in the order of room assembly
- Note: Front wall glass assembly is heavy and fragile.

Box #1: Floor, Ceiling, Bench Skirt, Bench, Manual & Door Handle Set

Box #2: Left & Right Walls

Box #3: Front & Back Walls

**Electrical Requirements:**

The IR Sauna Room is designed for a 230 Volt AC / 10 Amp Circuit Breaker!

A 230 Volt AC (dedicated) circuit is recommended to avoid unnecessary tripping of the breaker.

Record your model number and serial number in the event you should need to contact your dealer or technical support.



Serial number \_\_\_\_\_

Model number \_\_\_\_\_

Dealer name \_\_\_\_\_

**Sauna Assembly Instructions**

Floor Panel (Box #1):

- Locate the Floor Panel on a level surface 8-15 cm (3-6 inches) from wall and no more than 150 cm (5 ft) from 230 Volt AC / 10 amp dedicated receptacle.
- Position the Floor panel so that the Ceramic tiles / IR Floor Heaters are to the front of the room

**Note: place the Ceiling, Bench Skirt and Bench to the side until the appropriate steps.**

**Note: place the power cord on the ground to the side of the floor; be sure that all wires and connectors on the sauna floor are clear of the slots.**

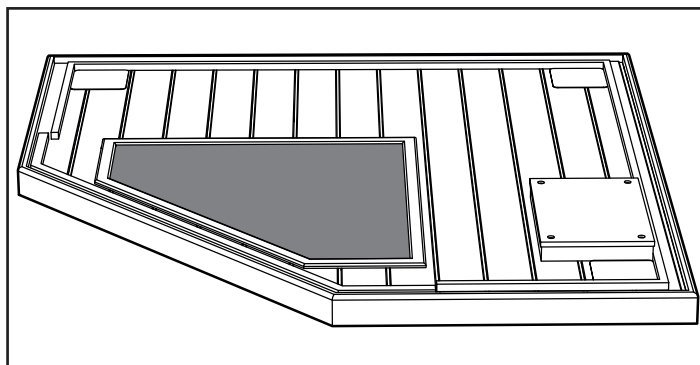

**Note – Do NOT Plug the Sauna Room 230 VAC Power Cord into the Outlet Yet!**

Right Back Wall (Box #3):

- Place Back Right Wall panel into the back slot of the Floor Panel.
- Back Right Wall panel must be held in place until the Back Left Wall panel is added.

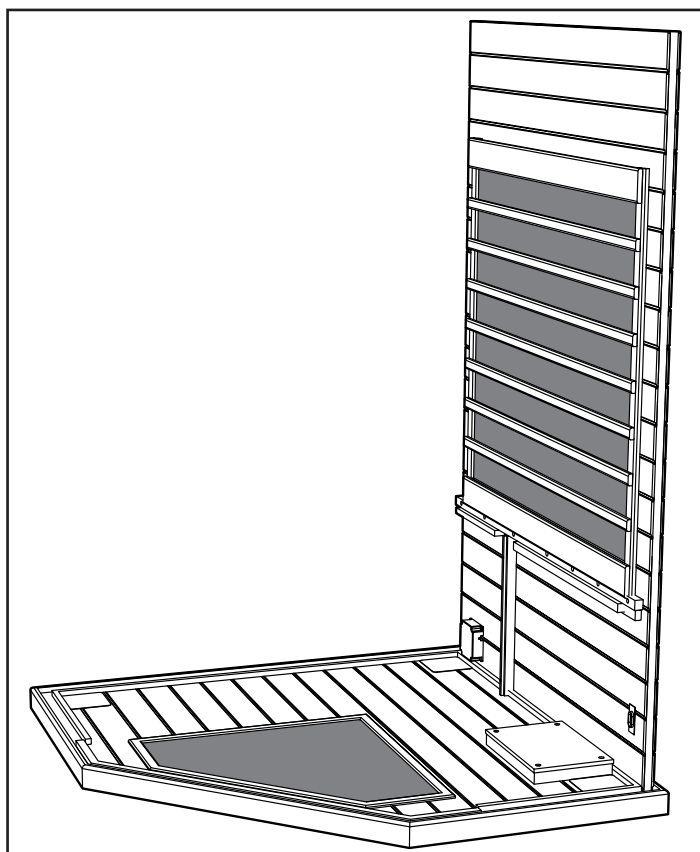

Left Back Wall (Box #3):

- Place Left Back Wall section into the left slot of the Floor Panel
- Attach Left Back Wall to the Right Back Wall by lifting up the Left wall sliding into the corner interlock brackets.

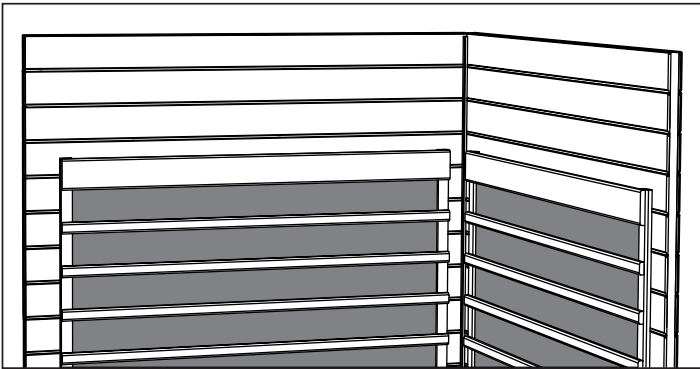
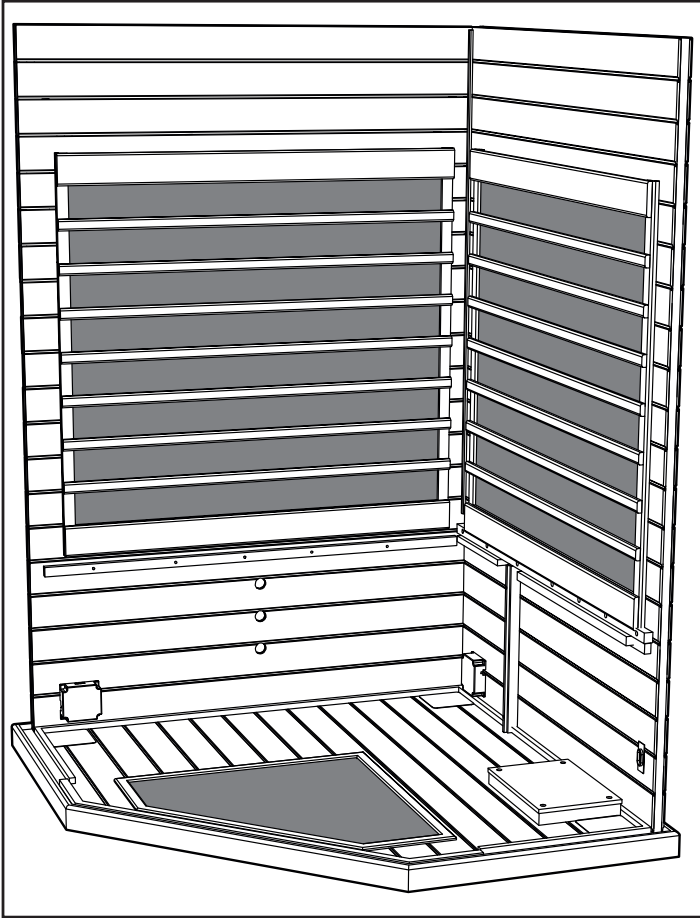

Left & Right Front Wood Walls (Box #2):

- Place Left Front Wall section into the left slot of the Floor Panel.
- Attach the Left Back Wall to the Left Front Wall by lifting up the Left Front Wall sliding into the corner interlock brackets.
- Place Right Front Wall section into the right slot of the Floor Panel.
- Attach the Right Back Wall to the Right Front Wall by lifting up the Right Front Wall sliding into the corner interlock brackets.

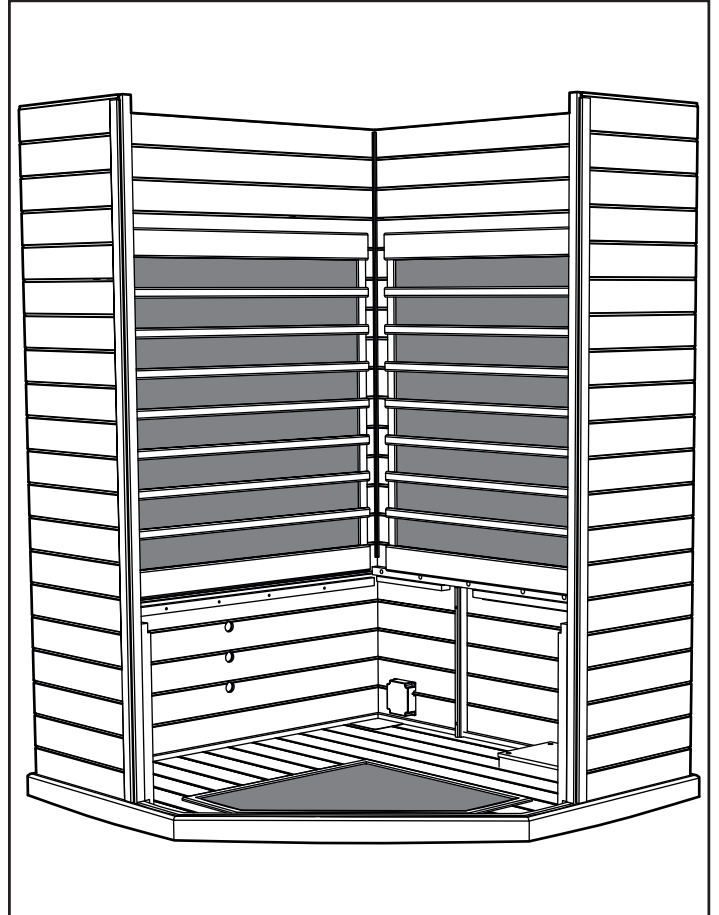

**Note:** When wall panels are connected in place properly the corners will be level and flush on top.

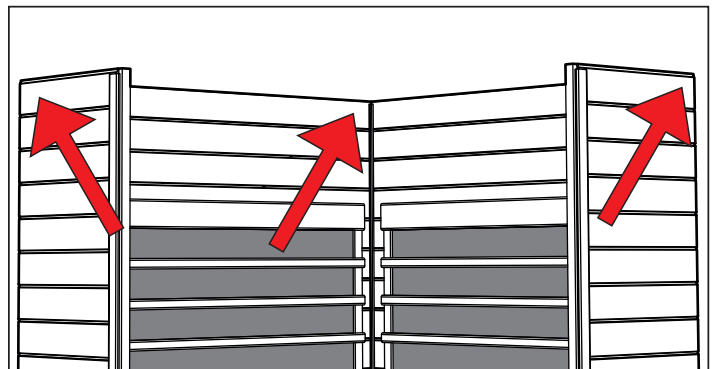

## Bench Skirt:

- Insert the left Bench Skirt in between the Right Back Wall and the Left Front Wall panels tracks.
- Slide Bench Skirt all the way to the floor. Do not pinch any wires under the skirt.
- Insert the right Bench Skirt in between the left Bench Skirt and the Right Front Wall.

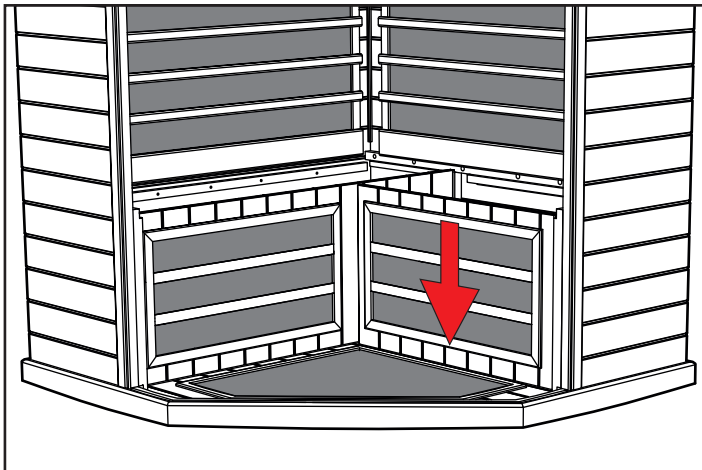
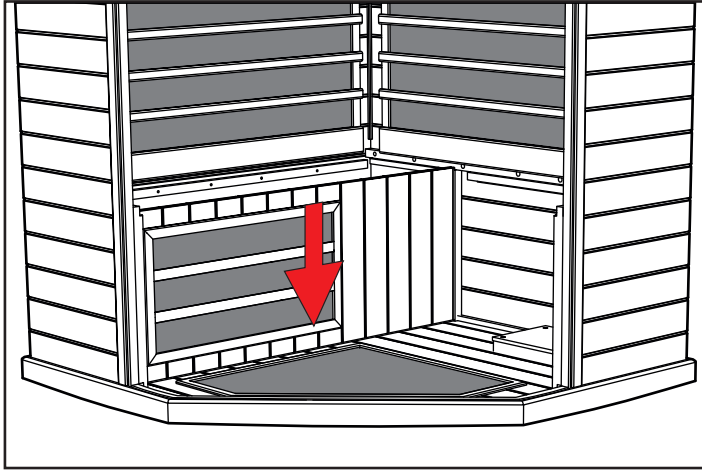

## Bench Top (Box #1):

- Slide the Long Bench seat down against the back wall with Power Junction Box facing you.
- Tilt the Bench against the Back Wall so it will remain standing.

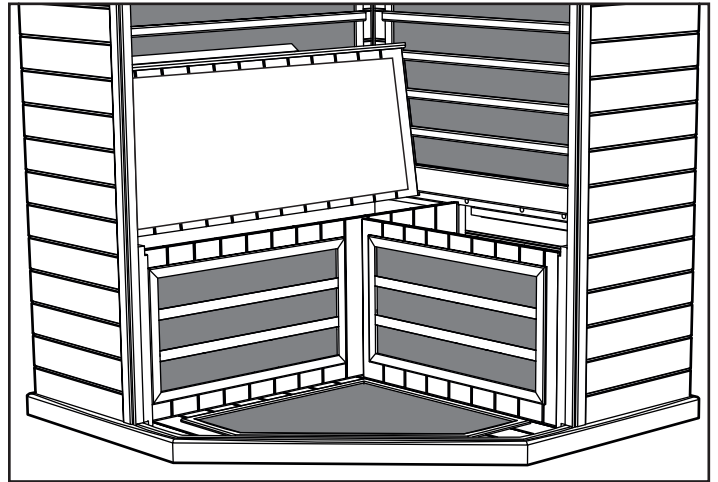

**Electrical Connections under bench**

Electrical Connections (under bench - left side):

- Connect wire L1 from the distribution plate to L1 from the Left Front Wall panel.
- Connect wire B1 from the distribution plate to B1 from the Left Back Wall panel.
- Connect wire #6 from the distribution plate to #6 from Bench Skirt.
- Connect wire S2 from the distribution plate to S2 from the Bench Top.
- Connect wire S4 from the distribution plate to S4 from the Bench Skirt.



Bench Top (Left Side):

- Install the left Bench Top by tucking the back of the bench under the heater guard. Push Bench Top all the way to the Left Back Wall.
- The Bench Top should fit down flush from front to back. It may be necessary to use the openings in the skirt to apply pressure forward or rearward on the skirt to allow the bench to drop into place.

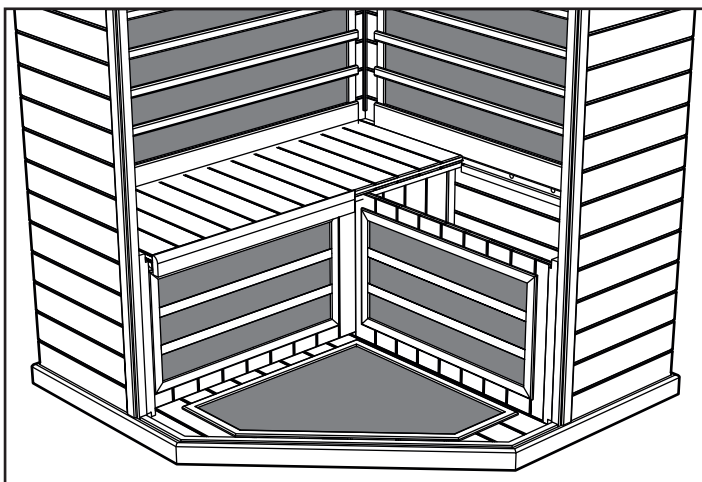

Electrical Connections (under bench - right side):

- Connect wire #4 from distribution plate to #4 from Back Wall harness.
- Connect wire #5 from the distribution plate to #5 from the Back Wall harness.
- Connect wire #6 from the Back Wall harness to the distribution plate wire #6.
- Connect wire R1 from the distribution plate to R1 from the Right Wall junction box.



- Connect wire S3 from the distribution plate to S3 from the Bench Skirt.
- Connect wire S1 from the distribution plate to S1 from the Bench Top.
- Connect wire #6 from the distribution plate to #6 on Bench Top.



- Locate the electrical switch on the black Master Control Box and ensure the switch is on.

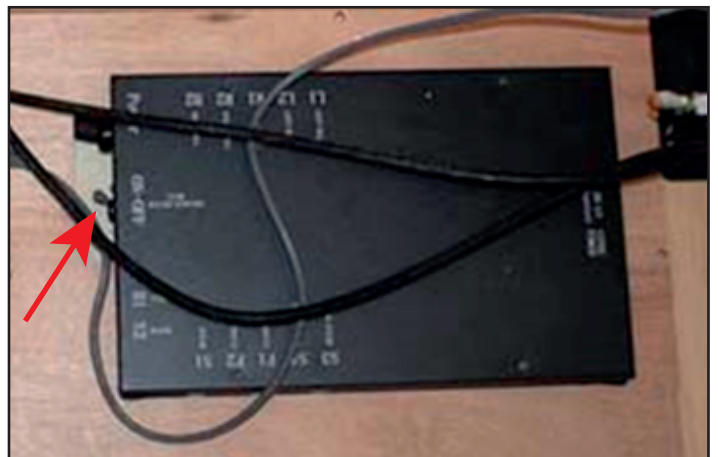

### Bench Top (Right Side):

- Install the Right Bench Top by tucking the back of the bench under the heater guard. Push Bench Top all the way to the Right Back Wall.
- The Bench Top should fit down flush from front to back. It may be necessary to use the openings in the skirt to apply pressure forward or rearward on the skirt to allow the bench to drop into place.

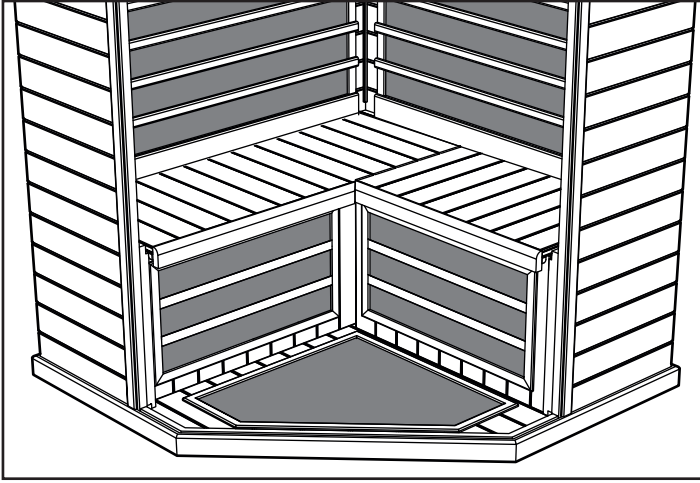

### Left & Right Glass Sidelights (Box #2):

- Place the Front Left Sidelight panel into the Floor panel slot and the adjacent Left Wall panel slot.
- Place the Front Right Sidelight panel into the Floor panel slot and the adjacent Right Wall panel slot.

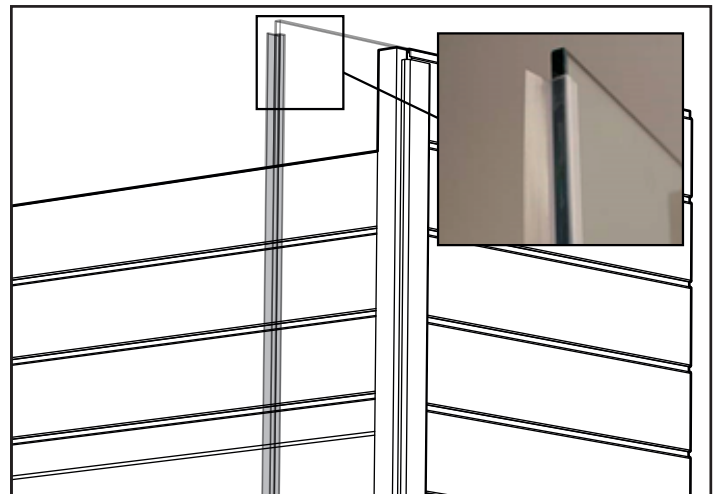
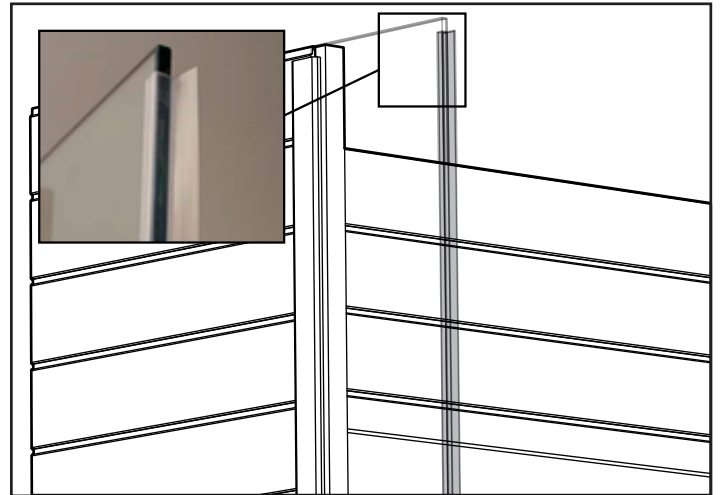
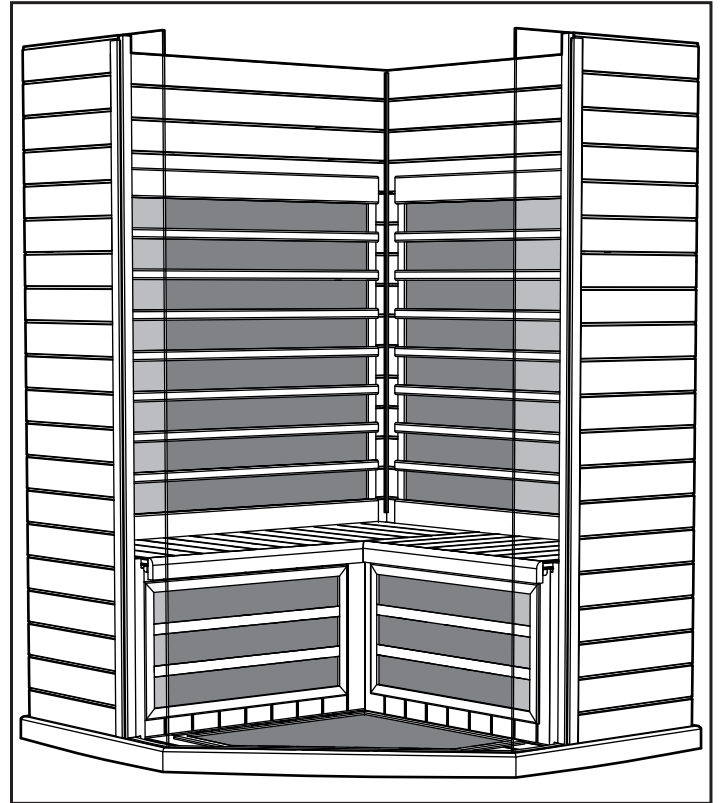

Ceiling (Box #1):

- The ceiling can now be set in place.



- Once the Ceiling panel is lined up directly above the Wall panels; insert the wires harnesses from the wall panels into the holes in the Ceiling panel.



**Note: Position the cam locks on the top of the Left & Right Wall panels as shown above.**

Front Wall Glass (Box #2):

- Place the Right Side Front / Door panel into the Floor panel slot.

**Note: Do not let go of glass panel, it needs to be held in place.**

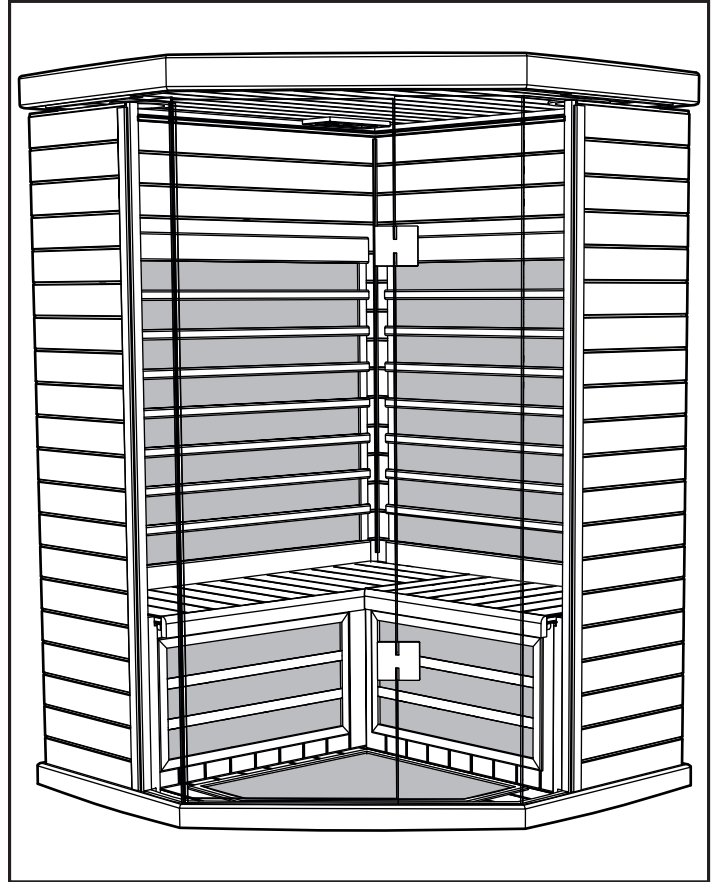

- While carefully still supporting the Front Wall Glass, one person on each side.
- Lower the Ceiling panel onto the Walls & Glass panels.
- Glass panels must recess into the slot in the Ceiling panel.

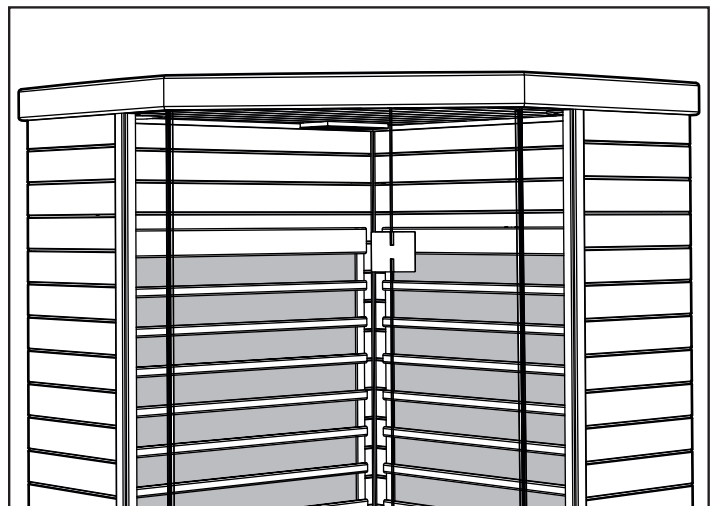

- Make sure the ceiling fits tight and is flat and level. *Be sure not to pinch any wires under the Ceiling panel.*
- Turn the wood ceiling cam locks to lock the ceiling into place.

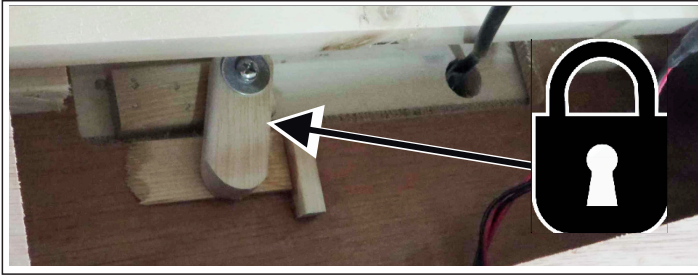

## Electrical Connections inside the Ceiling

Electrical Connections (inside the Ceiling panel-front right side):

- Open all hatch doors on the ceiling to locate the necessary electrical plugs.
- Access the connectors and connect them according to the labels on the harness.
- Connect wire #4 from the Back Wall harness to the Ceiling wire #4.
- Connect wire #5 from the Back Wall harness to the Ceiling wire #5.
- Connect wire #6 from the Back Wall harness to the Ceiling wire #6.
- Connect wire #7 from the Right Wall to the Ceiling Wire #7.



Electrical Connections (inside the Ceiling panel-rear left side):

- Near the Touch Screen harness in Ceiling connect Left Wall wire #3 to Ceiling wire #3.
- Connect Left Wall wire #7 to the Ceiling wire #7.
- Connect Left Wall wire F to Ceiling wire F.
- Connect Left Wall wire E to Ceiling wire E.



Sauna Room 230 Volt AC Power Cord:

- Plug the Sauna room power cord into the 10 amp wall receptacle.

**Note: It is important that the sauna be plugged into a dedicated outlet of the correct rating. Plugging your sauna into a shared circuit through can cause poor performance, circuit breaker tripping, or overheating of the circuit.**

Door handles:

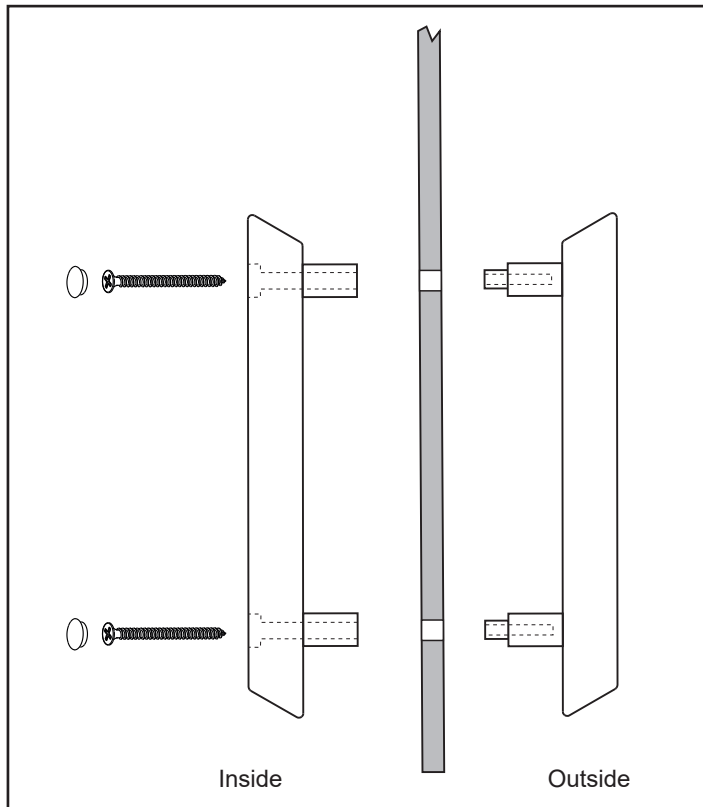
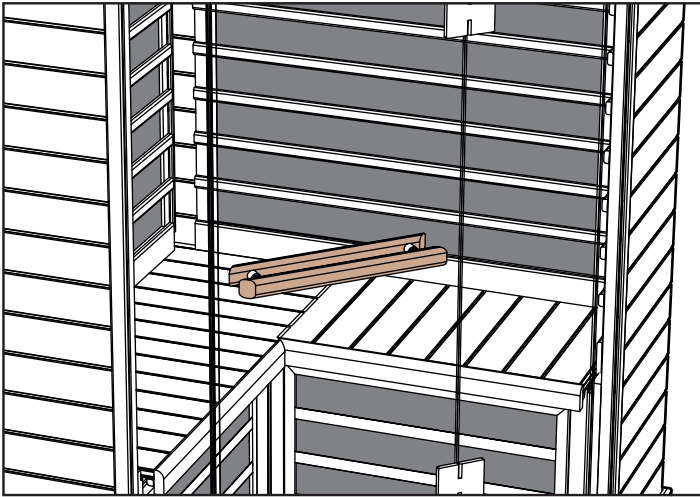

### How to Use Infrared Sauna:

Avoid eating large meals and excessive alcohol intake before using Sauna.

Never smoke or drink alcohol or exercise inside of Sauna.

If you are taking any medications or under the care of a Physician, consult with them prior to Sauna usage. Refer to Sauna Usage Warning signs located inside of Sauna Room

Prior to Sauna session, if possible before using Sauna, take a warm shower without drying.

Note! Avoid using wet clothes in the sauna, use a dry towel or similar to sit on to protect the wood.

Clothing is optional or wear loose fitting clothes. You may choose to sit or lie on a clean soft towel.

Set desired time & temperature.

The Sauna is producing the correct wavelengths to be absorbed into the body within 10-15 minutes of operation. It is not necessary to wait until the sauna is at maximum temperature; the absorption of wavelength is the same whether the room is in heat up or at set temperature.

Enter Sauna and relax, you may choose to enjoy music. Refer to the above Color Therapy System instructions.

Sit or lie on bench. Close the door and open the interior ceiling vent allowing for fresh air circulation.

Remain in the Sauna long enough to warm up and stimulate a mild perspiration. Typically that may occur in 10 – 15 minutes.

This varies with every individual and their comfort level. Do not over do it!

Drink plenty of cool water or a refreshing healthy drink while using the sauna.

Leave the Sauna and cool down. Shower or bathe if possible to cool down and cleanse the skin.

Cool down period usually is the same length of time as the Sauna session.

Then reenter the Sauna for another 10-15 minute session.

Continue this process of alternating using the Sauna and Cooling Down for 3 to 4 cycles.

Length of time in the Sauna and cool off period varies and depends on the individual.

After final Sauna session and upon leaving the Sauna turn the Sauna off the timer if it is still operating.

Open the door and clean the Sauna walls, bench and floor areas with a soft clean damp cloth.

Enjoy a final shower or bath to cool down. Relax, in the special "after sauna glow" and you may choose to enjoy a healthy snack and cool drink.

### Maintenance / General Cleaning

#### Tips:

DO NOT USE: Alcohol or any strong Cleaning Chemicals

*Note: Some chemicals can damage clear finish and wood surfaces.*

- Interior: Perspiration and dirt may absorb into the wood, so periodic cleaning is needed, scrubbing benches, back supports, floor boards and walls with a stiff brush and mild detergent is normally sufficient. Light sanding is another option for cleaning interior surfaces.
- Exterior: Use a damp cloth of a mild soap mixed with warm water.

Tips & Troubleshooting:

a. Main Control Touch Pad Lights Not Lit:

- Ensure electrical connections between ceiling and back and the ceiling and front wall
- Ensure power cord is plugged in to the proper power receptacle and dedicated circuit breaker
- Ensure main circuit breaker (house) is not tripped (power is found at the receptacle)
- Ensure the room main controller circuit breaker (under the bench) is not tripped and is ON

b. Room not heating:

- Ensure power cord is plugged in to the power receptacle
- Ensure main circuit breaker (house) is not tripped (power is found at the receptacle)
- Ensure the room main controller circuit breaker (under the bench) is not tripped and is ON

- Ensure room desired temperature is greater than room actual temperature (controller demands heat)
- Ensure that there is no time in the Delay Start timer if you do want to delay the start
- c. Door rubbing or binding:
  - Ensure that the room is assembled properly; walls and ceiling should all be interlocked.
  - Ensure the floor is flat by using a level on the ceiling of the room. It may be necessary to use a small door or window shim to adjust the level under the floor.

Wiring diagram:

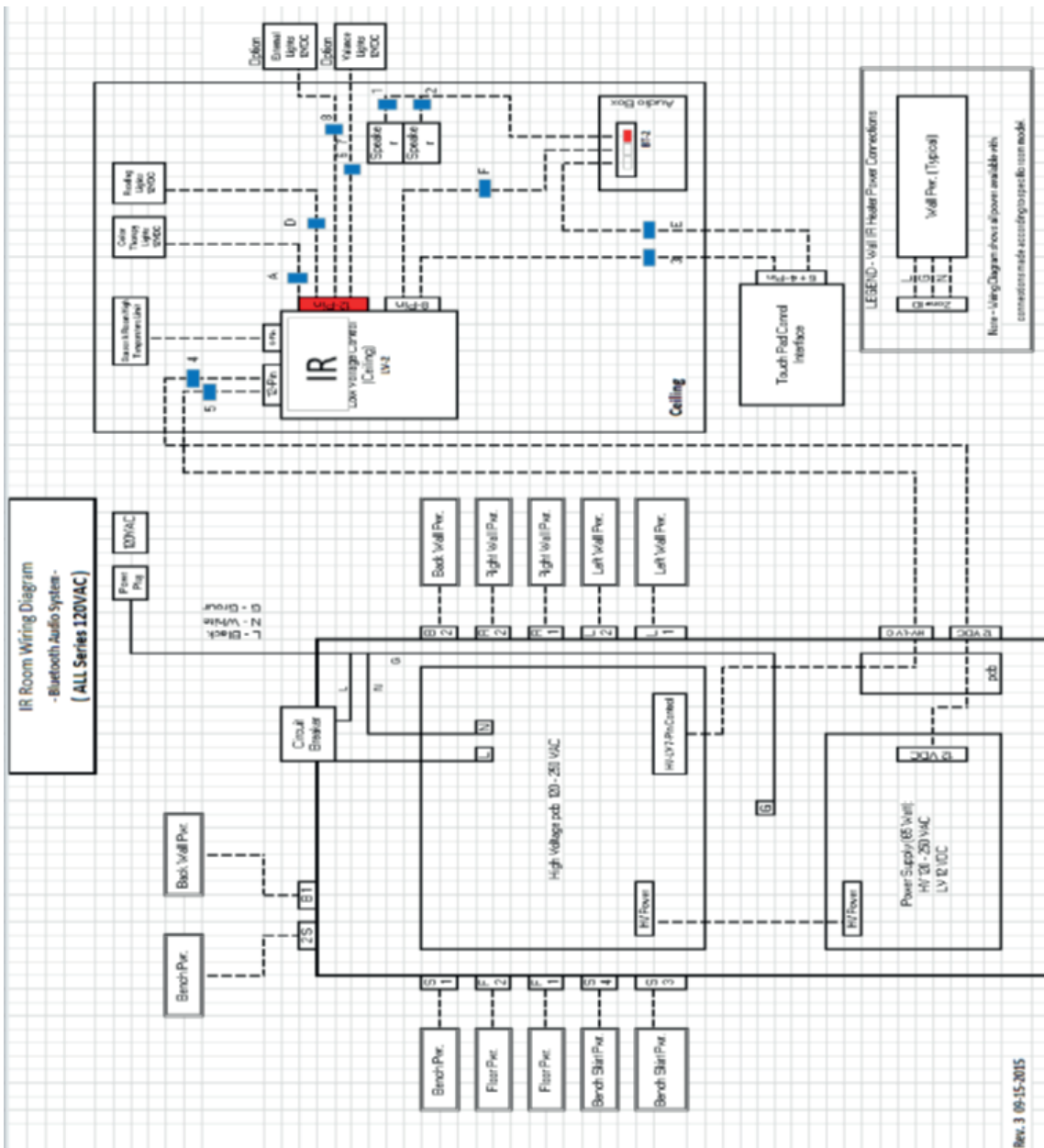

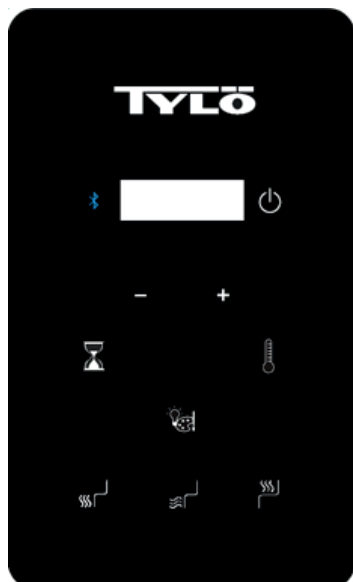



### Operating Instructions

Default settings for temperature are preset to 65°C, the time is set to 60 minutes. These settings are adjustable as described below. Any changes are remembered by the room for your next bath. Should the room power be lost then restored, the settings will return to their default values.

#### STARTING IR2

Press the start  icon once.



The default setting is that all heaters are active. You have the possibility to turn on/off heaters by pressing  (floor),  (skirt) and/or  (bench). The wall heaters are always on when start button is activated.

#### SETTING THE TIME AND TEMPERATURE

To set the sauna length time, press the  icon and then press the “+” or “-” icons to increase or decrease time for desired setting. The maximum of time is 60 minutes.

To set the temperature, press the  and next “+” or “-” icons to increase or decrease temperature for desired setting. The minimum temperature is 25°C and maximum temperature is 65°C.

#### Operating Instructions for Lighting

Press  icon to cycle through lighting options. Press and hold the  icon for 3 seconds to turn off the lights. Lights will turn off automatically 10 minutes after sauna cycle is completed.

- Color sequence – White – Red – Green – Blue – Yellow – Aqua – Purple – Rotation of Colors – Off

Choose the color of choice and then set lighting brightness. The brightness will be on display for 3 seconds. Press the “+” or “-” icon to increase or decrease the light setting. Setting options are 25, 50, 75, and 100% light output.

#### Audio operation

Audio Power On:

Press  icon to toggle On or Off the Bluetooth® System.

*Note: The control does not have to be active for Sound System to operate.*

#### Pairing

- Refer to your mobile device to pair to the unit.
- The Room device name is TyloHelo Audio

#### Operation

- All operations are controlled by the mobile device
- Volume is controlled by the mobile device

### SaunaLogic App Quick Start Guide

How to Pair IR2 Control to SaunaLogic App:

The SaunaLogic App allows you to turn your sauna on/off, set temperature, turn on Bluetooth, adjust lighting, and more from the convenience of your smart phone or tablet. The following are the steps to pair your IR2 Control to the SaunaLogic App.

**NOTICE: THE SAUNA HEATER AND IR2 CONTROL MUST BE INSTALLED AND OPERATIONAL PRIOR TO PAIRING TO THE SAUNALOGIC APP.**

1. Download the SaunaLogic App and install onto your smart phone or tablet by scanning the QR Code below or searching for "SaunaLogic" in the appropriate app store.



2. Register a New Account: When you open the SaunaLogic App for the first time, you will be given the option to Register or Login with Existing Account. You will need to select Register and follow the prompts to complete the registration requirements. A valid email address or a mobile phone number will be required to complete the registration process.

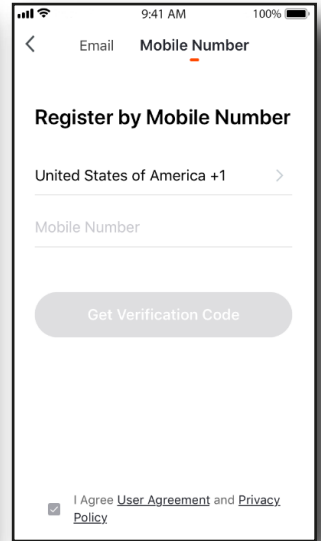
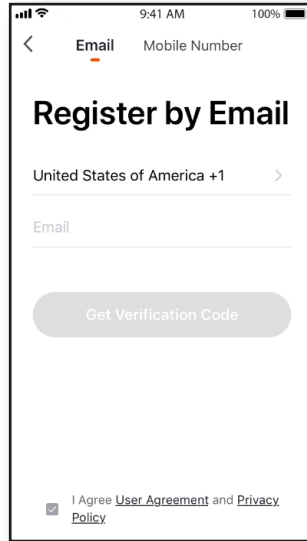

3. Login with Your Account: After completing the account registration requirements, you will be able to login with the credentials you provided during that process.

**NOTICE: BEFORE MOVING TO THE NEXT STEP (Add Device) YOU WILL NEED TO MAKE SURE THAT THE PHONE OR TABLET THAT YOU ARE GOING TO USE TO PAIR THE IR2 CONTROL TO THE SAUNALOGIC APP IS CONNECTED TO A WIFI NETWORK THAT IS CONFIGURED FOR 2.4GHz AND PROVIDES A STRONG SIGNAL WHERE THE IR2 CONTROL IS LOCATED.**

4. Add Device: While on the Home screen, within the SaunaLogic App, Tap on "Add Device" or the Plus Symbol (+) at the top right corner to add a device.

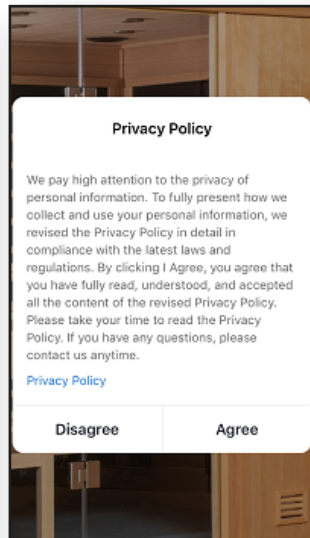
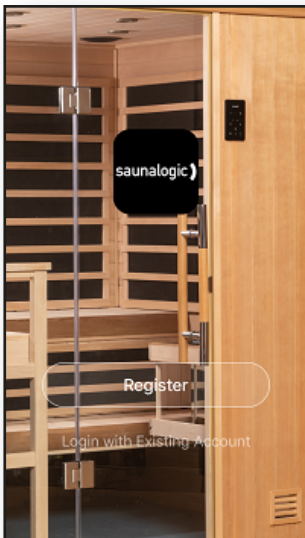
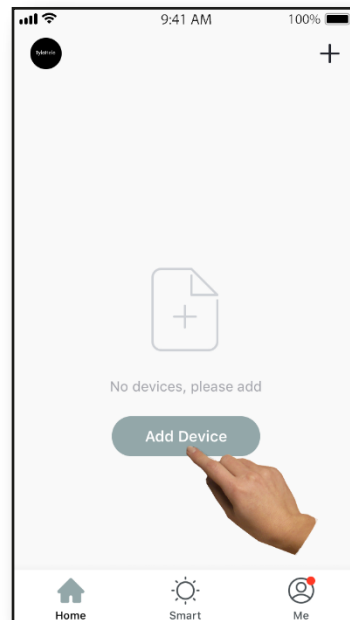

5. Select Sauna: On the Add Manually screen, within the SaunaLogic App, Tap on the Control Icon labeled "Sauna".

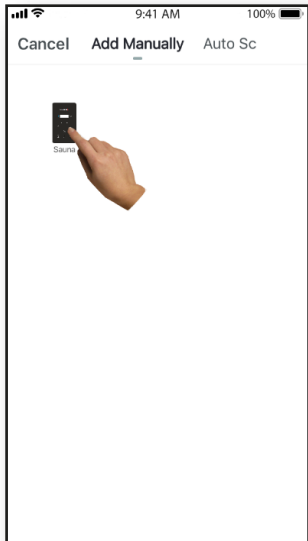

6. Put the SaunaLogic 2 Control into pairing state by pressing on the Bluetooth® Button until "con" appears on the control display. Press the Bluetooth® button again and release when you hear a signal. Then, tap on the 'Confirm "Con" is on Control' Button within the SaunaLogic App.



IR2 control

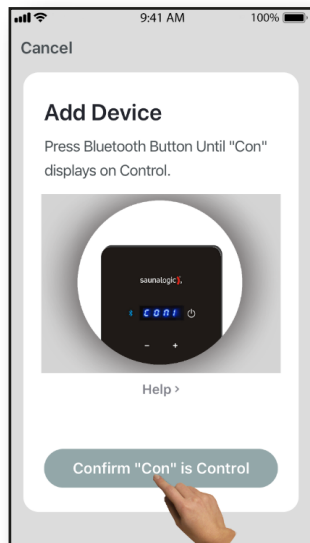

Sauna Logic App

7. Connect to your desired Wi-Fi Network, enter your Password and then tap on the Confirm Button.

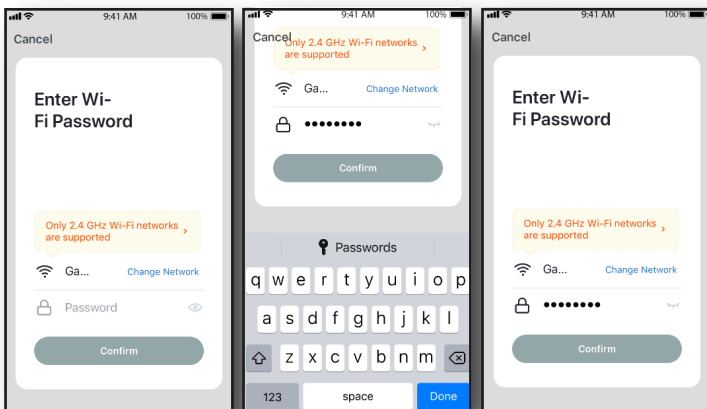

8. Connect your mobile phone to the IR2 Control's hotspot that is identified in the SaunaLogic App.

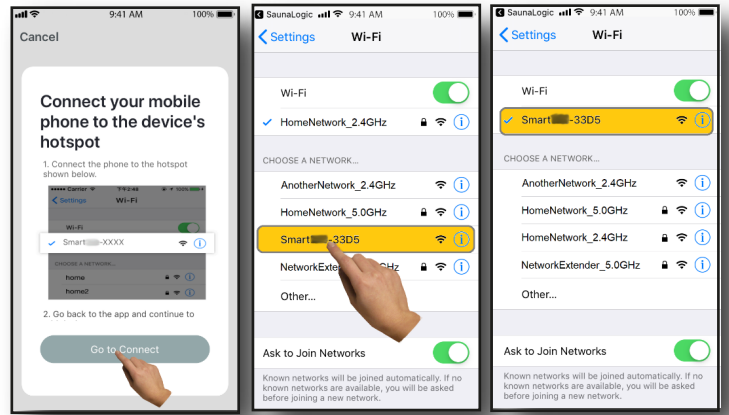

9. Once you have selected and connected to the IR2 Control's hotspot, tap on "SaunaLogic" located at the top left of the screen to go back to the SaunaLogic App and continue with the pairing process.

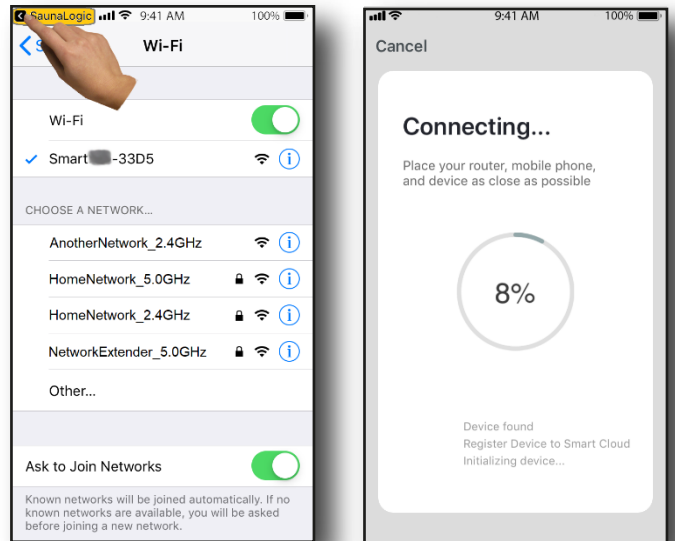

10. If you get a message that reads "Network is unavailable, please check the network" it means that the connection has failed. Tap "OK" and repeat steps 6 – 9.

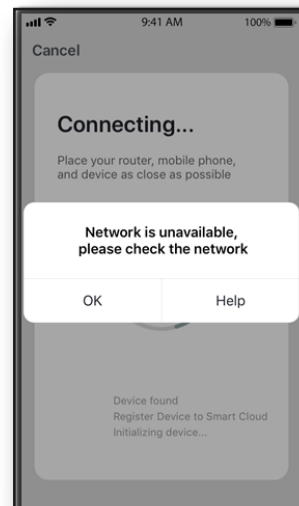

- 11. If you get a message that reads “Device not responding Check demerit points and retry” it means that the connection has failed. You may need to put the IR2 Control into pairing mode again, and repeat steps 6 – 9.

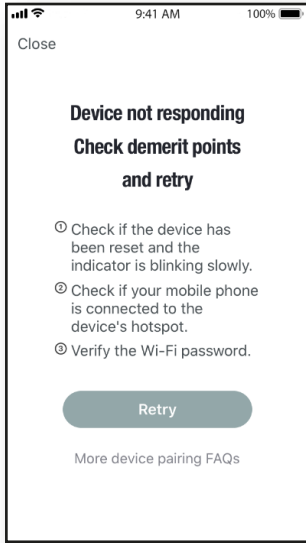

- 12. Once your IR2 Control successfully connects to the SaunaLogic App, your App screen will pop up with a message stating “Device added successfully” (Figure A) and give you the option to edit the name of your IR2 Control.

You may choose to keep the default name or rename it to something else of your choosing. Keep in mind that it is best to keep this name simple so that if you end up configuring to work with Alexa, Google Assistant or Siri, it will be easier for the smart assistant to understand when you are trying to control the IR2 Control with voice commands.

- Tap, “Done” if you decide to keep the default name.
- Tap on the icon  if you decide to change the device name. The onscreen keyboard will pop up and allow you to edit the device name (Figure B).
- Tap “Save” once you are satisfied with the device name change and then tap “Done”.

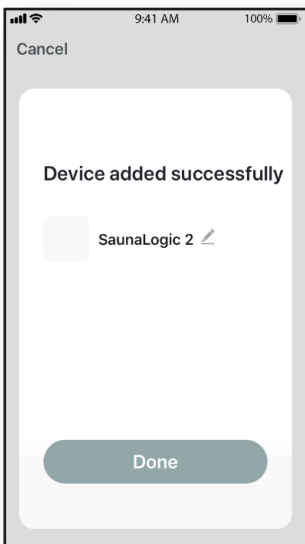

Figure A

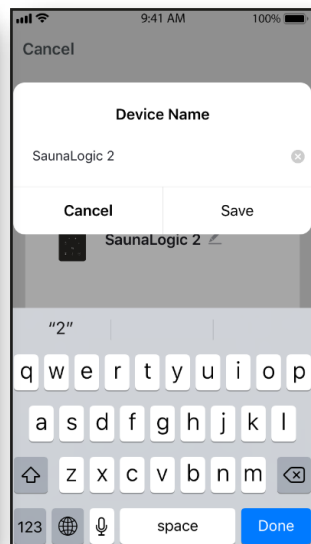
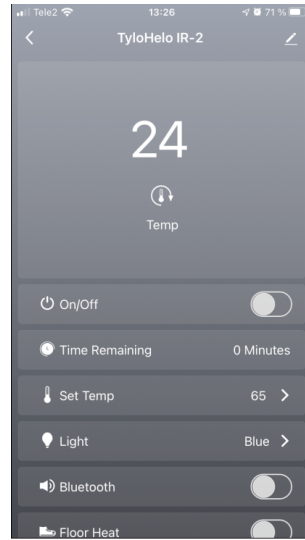
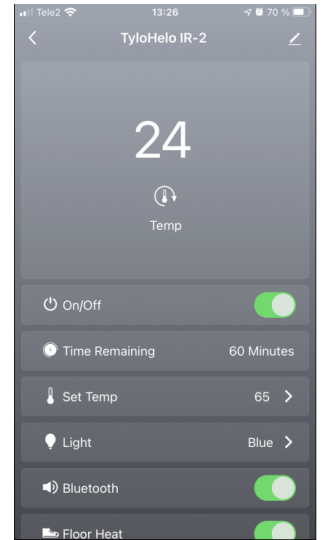

Figure B

- 13. You should now be able to control your IR2 Control with the SaunaLogic App. Tap the  On/Off button on the control screen within the SaunaLogic App to turn your sauna on and gain access to the control functions.



OFF



ON

NOTE: THE SAUNA MAY ALSO BE TURNED ON / OFF FROM THE HOME SCREEN BY TAPPING THE  BUTTON, NEXT TO THE IR2 CONTROL ICON (SEE BELOW).

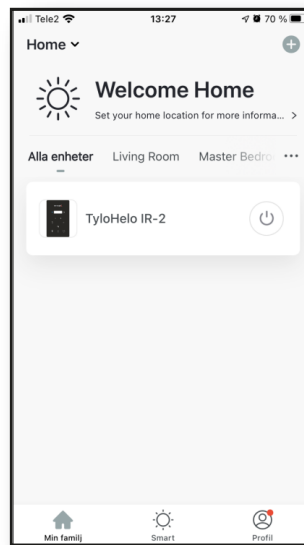

OFF

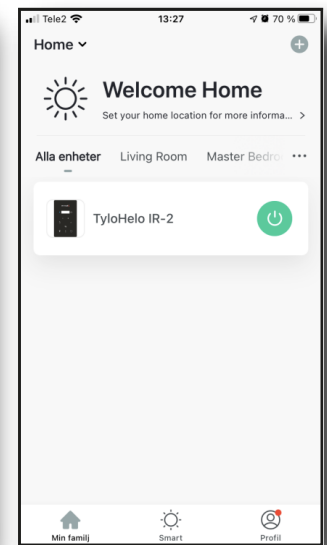

ON

NOTICE: IT IS ONLY ONE PHONE THAT CAN AND NEEDS TO BE PAIRED. ALL OTHER USERS NEED TO BE A PART OF THE SAME “FAMILY”. THE PHONE THAT IS PAIRED IS THE ADMINISTRATOR AND GIVES ACCESS TO THE “FAMILY” CREATED TO ALL OTHER USERS BY ADMITTING THEIR ACCOUNTS (ALL USERS NEED TO CREATE AN ACCOUNT, SEE STEP 2)

Troubleshooting:

-Not able to find the hotspot SMARTxxx (step 8):

- Please make sure that you are connected to a 2,4 GHz Wi-Fi network.
- This can also happen after pairing several times. Try clearing the memory through unplugging the room from the wall socket. Wait 60 seconds, and then plug in again. Now retry from step 6.