

TYLÖ RELAY BOX COMMERCIAL/ COMMERCIAL LITE

2017-12-04

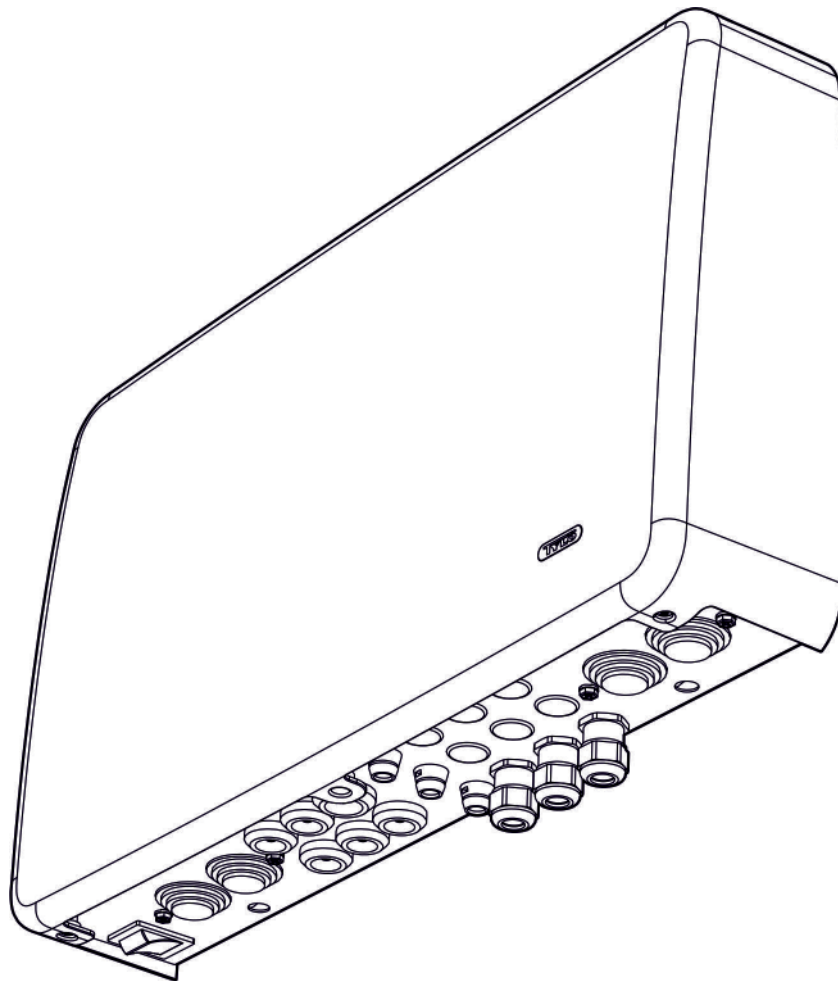

SVENSKA
ENGLISH
FRANÇAIS
РУССКИЙ
DEUTSCH
NEDERLANDS
POLSKI

2900 4153

TYLÖ[®]
for the senses

Inkopplingschema
 Connections diagram
 Schémas de câblage
 схема соединений

Schaltplan
 Aansluitingsdiagram
 Schema połączeń

Type Sense Commercial 6-8-10, Expression 6-8-10 400 V 3N~

1 = SENSE COMMERCIAL 6-8-10, EXPRESSION 6-8-10 2 = RB COMMERCIAL/RB COMMERCIAL LITE
 2A = RB COM./RB COM LITE PCB 2B = RB COMMERCIAL LITE 2C = RB COMMERCIAL 3 = CONTROL PANEL PURE/ELITE
 4 = SENSOR 5 = DOOR SWITCH

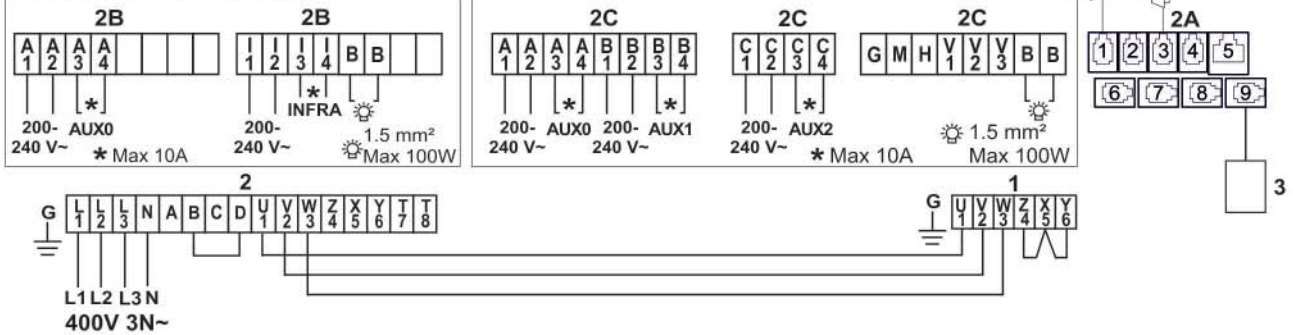

Type Sense Commercial 16-20 400 V 3N~

1 = SENSE COMMERCIAL 16-20 2 = RB COMMERCIAL 2A = RB COMMERCIAL PCB 3 = CONTROL PANEL PURE/ELITE
 4 = SENSOR 5 = DOOR SWITCH

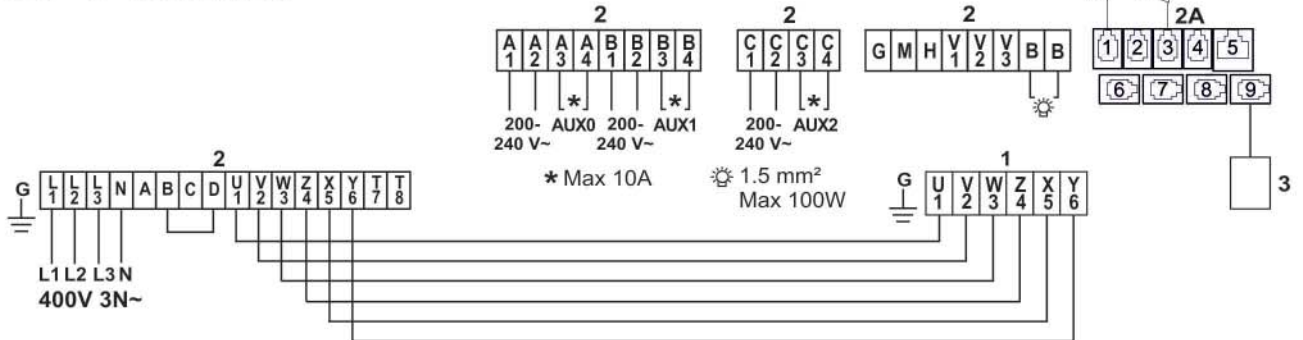

Type Sense Commercial 6-8-10, Expression 6-8-10 * 200-208-230-240 V 1/3~
Type Sense Commercial 16-20 ** 200-208-230-240 V 3~

1 = SENSE COMMERCIAL 6-8-10, EXPRESSION 6-8-10 2 = RB COMMERCIAL/RB COMMERCIAL LITE
 2A = RB COM./RB COM LITE PCB 2B = RB COMMERCIAL LITE 2C = RB COMMERCIAL 3 = CONTROL PANEL PURE/ELITE
 4 = SENSOR 5 = DOOR SWITCH

* 10,7 kW not approved for single-phase in Europe. ** 16-20 kW only with relay box Commercial.

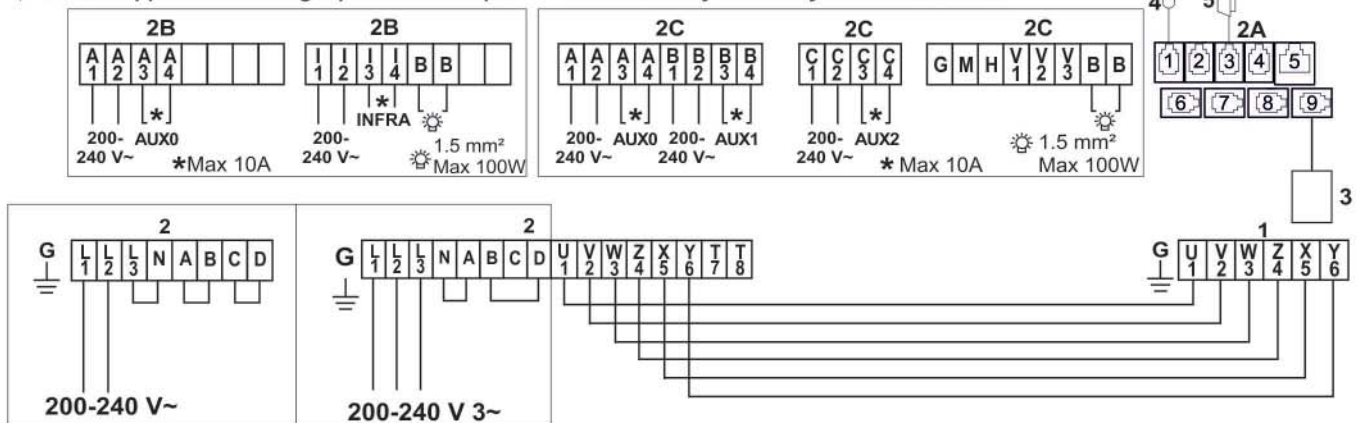

Type	kW	400 V 3N~ Amp	400 V 3N~ mm²	200-208 V 3~ Amp	200-208 V 3~ mm²	230-240 V 3~ Amp	230-240 V 3~ mm²	200-208 V~ Amp	200-208 V~ mm²	230-240 V~ Amp	230-240 V~ mm²
SENSE COMMERCIAL 6 EXPRESSION 6	6.6	10	1.5	19	4	17	4	33	10	29	10
SENSE COMMERCIAL 8 EXPRESSION 8	8	12	2.5	23	6	20	4	40	16	35	10
SENSE COMMERCIAL 10 EXPRESSION 10	10.7	16	2.5	31	10	27	10	-	-	-	-
SENSE COMMERCIAL 16	16	23	6	46	16	40	16	-	-	-	-
SENSE COMMERCIAL 20 EXPRESSION 10	20	29	10	58	25	50	16	-	-	-	-
	10	16	2.5	31	10	27	10	-	-	-	-

Don't forget to earth (ground)!
 Glöm inte att jorda!
 Vergessen Sie nicht zu erden!
 N'oubliez pas la mise à la terre!

RB COMMERCIAL

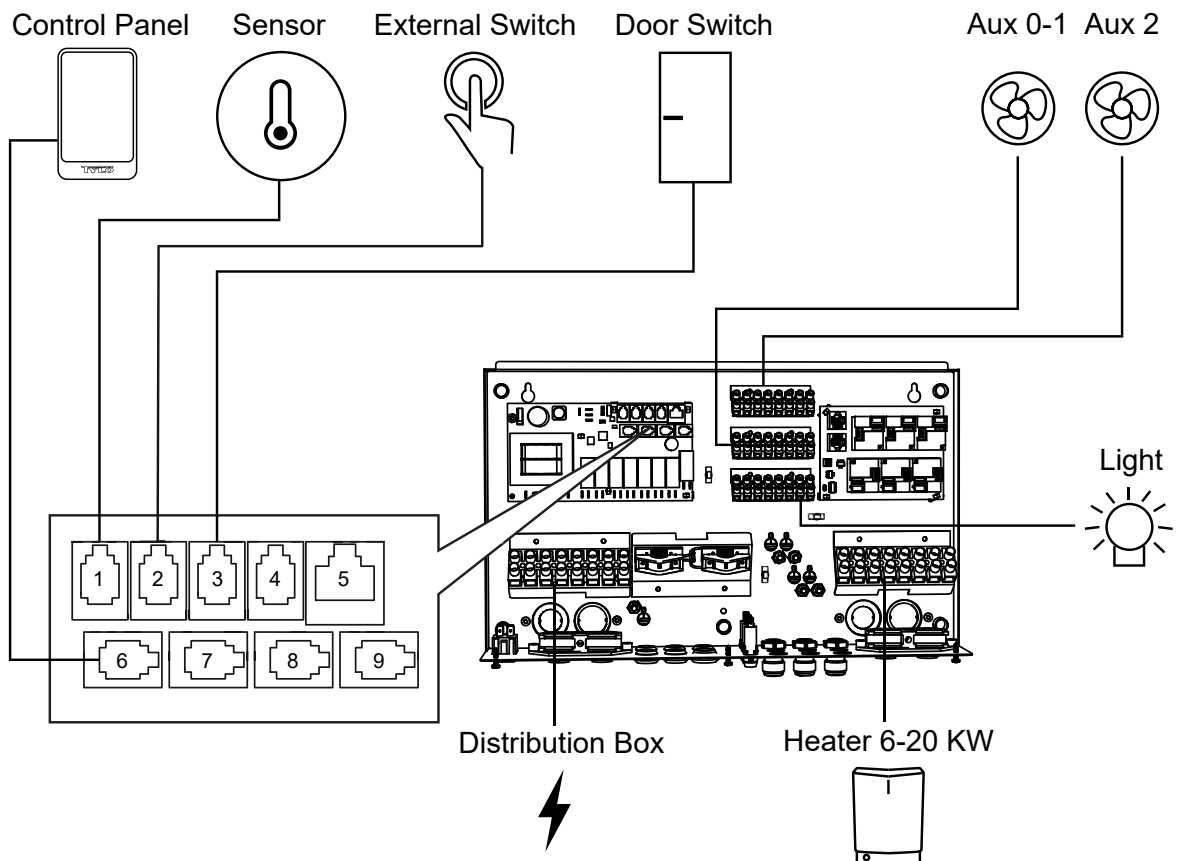
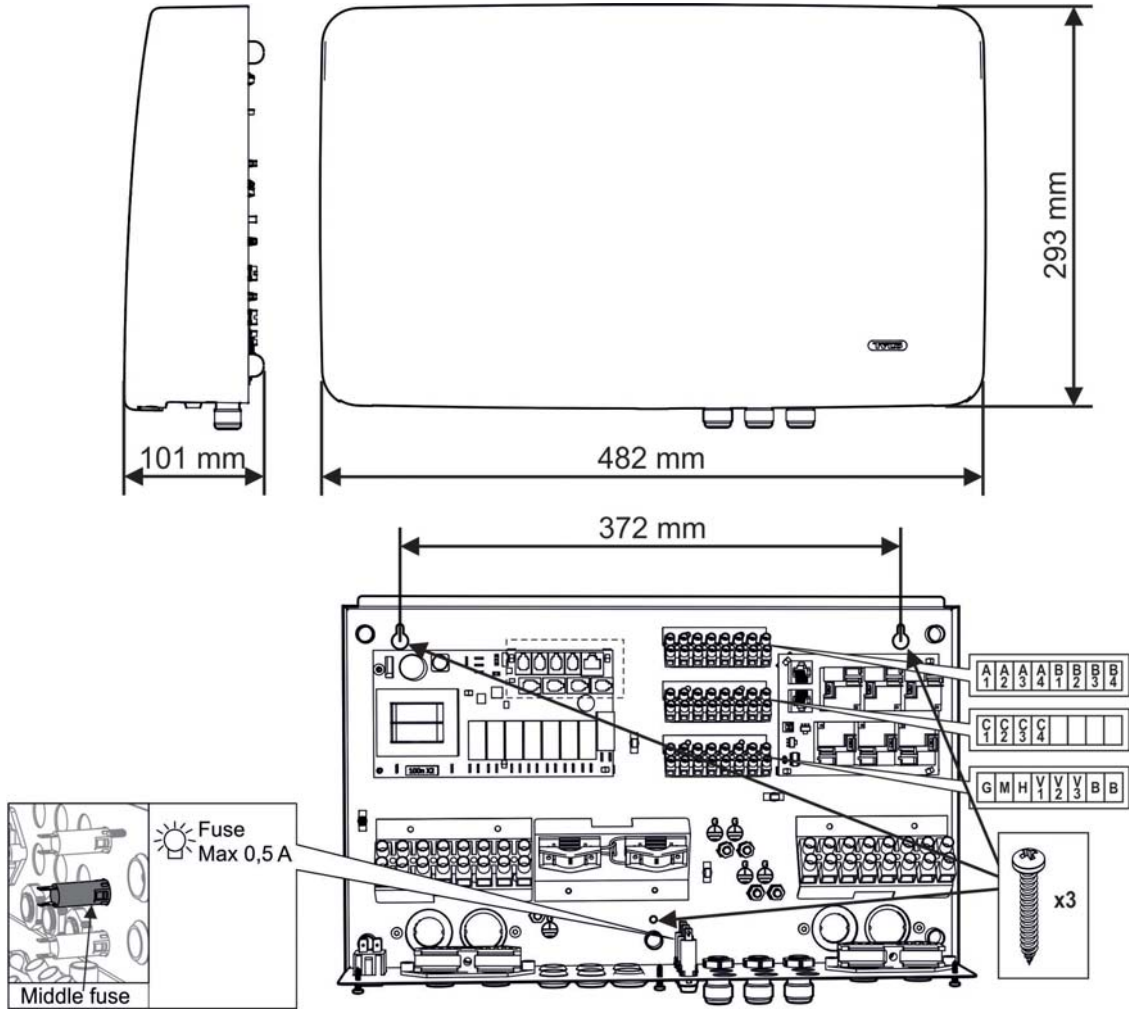

RB COMMERCIAL LITE

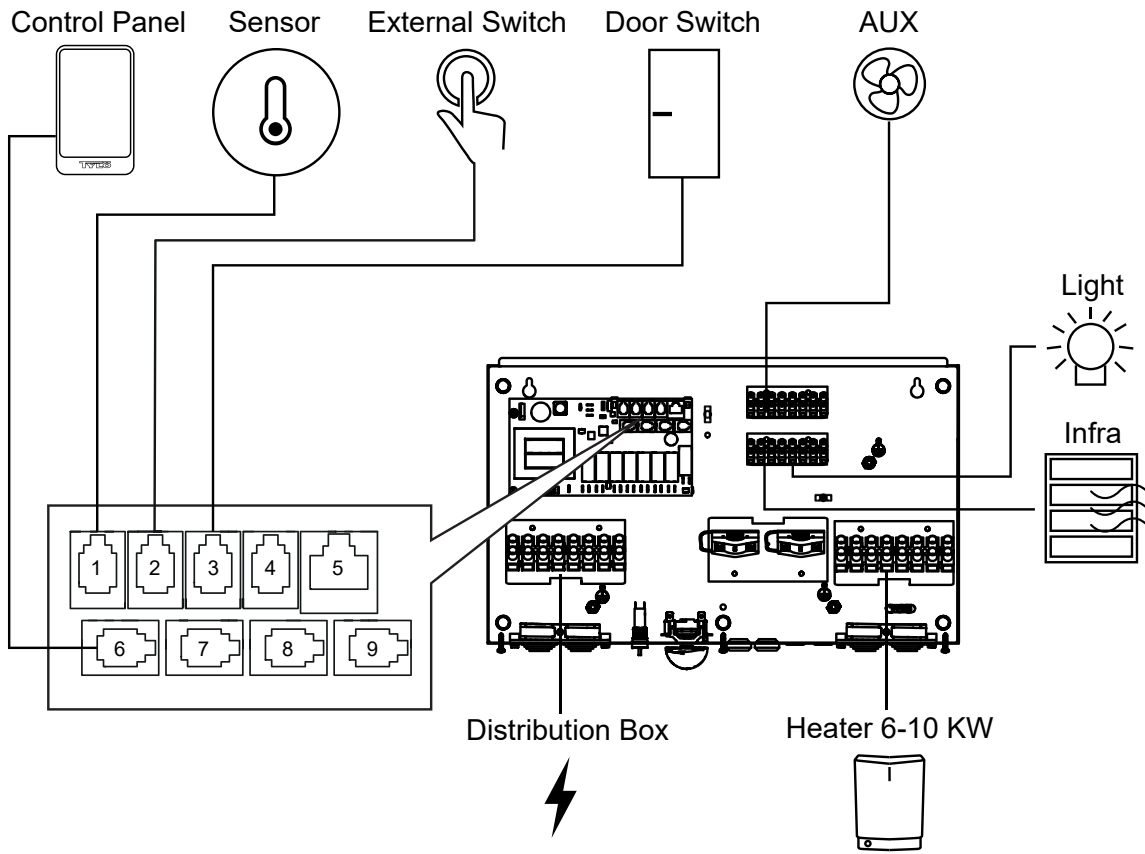
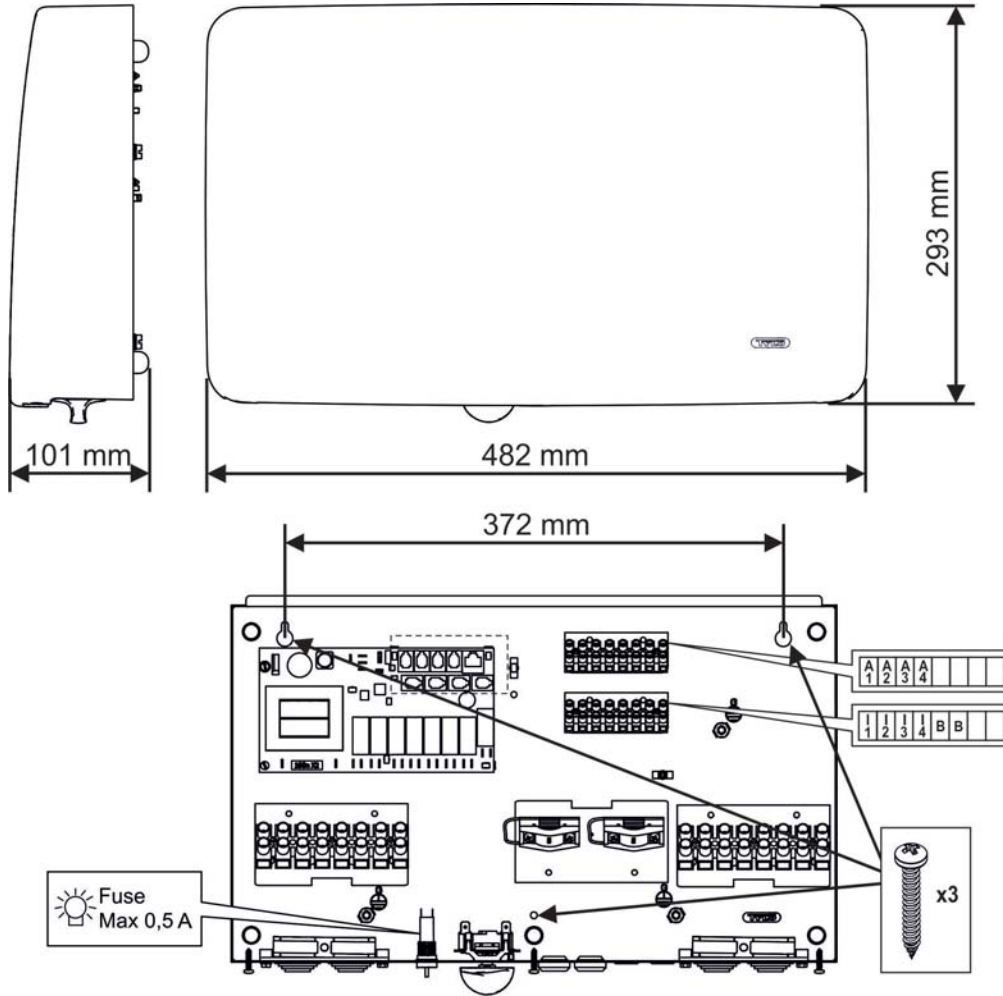

SVENSKA

Beskrivning av modularkontakt

Pos 1.	Pos 2.	Pos 3.	Pos 4.	Pos 5.
NTC	Ext sw	Door sw	Bim/NTC	Addon (option)
Pin 1:	Pin 1:	Pin 1:	Pin 1: Bim	
Pin 2: NTC	Pin 2: LED	Pin 2: LED	Pin 2: NTC	
Pin 3: NTC	Pin 3: SW	Pin 3: SW	Pin 3: NTC	
Pin 4:	Pin 4: 12 V	Pin 4: 12 V	Pin 4: Bim	

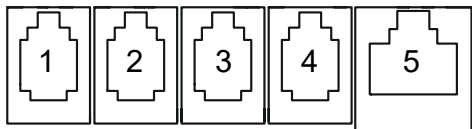

Pos 6-9. 4x RS485

Pin 1: A
Pin 2: B
Pin 3: 12 V
Pin 4: GND

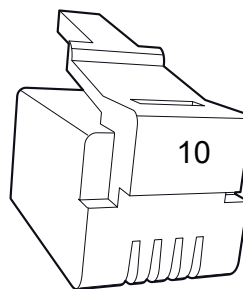
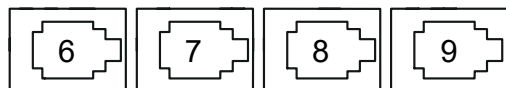

Pin: 1 2 3 4

Pin: 4 3 2 1

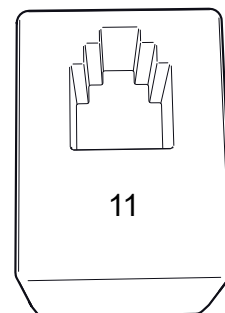

- | | | |
|------------------------------------|--------------------------------|--------------------------------|
| 1. NTC Sensor (RJ10) | 5. Addon (tillval)(RJ45) | 9. RS485 manöverpaneler (RJ10) |
| 2. Externbrytare (RJ10) | 6. RS485 manöverpaneler (RJ10) | 10. Modularplugg (RJ10) |
| 3. Dörrkontakt (RJ10) | 7. RS485 manöverpaneler (RJ10) | 11. Modularkontakt (RJ10) |
| 4. SEC/NTC Sensor (tillval) (RJ10) | 8. RS485 manöverpaneler (RJ10) | |

Inkoppling av komponenter i modularkontakter (max. kabelarea till RJ10: 0,9mm/ 0,2mm², AWG24)

Enhet	Pos	Pin	Anmärkning
Tempsensor (10kΩ)	1	2-3	Skall vara av modell NTC. Kan även kopplas in på Pos. 4.
Externbrytare utan LED-indikering	2	3-4	Både konstant- eller impulsslutning fungerar.
Externbrytare med LED-indikering	2	2-3-4	12VDC (max 40mA). Tylö externbrytare artikelnr: 9090 8045
Dörrkontakt utan larm för dörrstatus	3	3-4	Av modell NO (Normally Open). Tylö dörrkontakt artikelnr: 9090 8035.
Dörrkontakt med larm för dörrstatus	3	2-3-4	12VDC (max 40mA)

ENGLISH

Modular connector description

Pos 1.	Pos 2.	Pos 3.	Pos 4.	Pos 5.
NTC	Ext sw	Door sw	Bim/NTC	Addon (option)
Pin 1:	Pin 1:	Pin 1:	Pin 1: Bim	
Pin 2: NTC	Pin 2: LED	Pin 2: LED	Pin 2: NTC	
Pin 3: NTC	Pin 3: SW	Pin 3: SW	Pin 3: NTC	
Pin 4:	Pin 4: 12 V	Pin 4: 12 V	Pin 4: Bim	

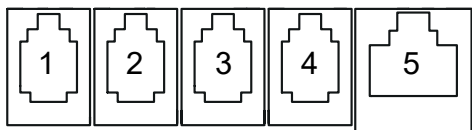

Pos 6-9. 4x RS485

Pin 1: A
Pin 2: B
Pin 3: 12 V
Pin 4: GND

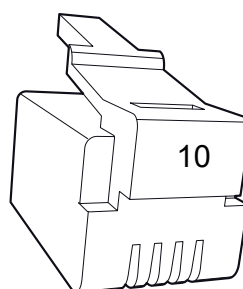
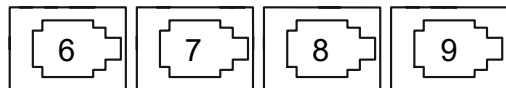

Pin: 1 2 3 4

Pin: 4 3 2 1

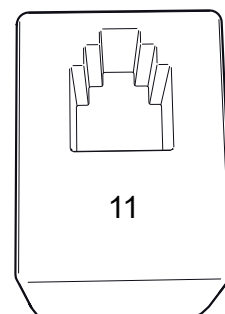

- | | | |
|-----------------------------------|--------------------------------|--------------------------------|
| 1. NTC Sensor (RJ10) | 5. Addon (option)(RJ45) | 9. RS485 control panels (RJ10) |
| 2. External switch (RJ10) | 6. RS485 control panels (RJ10) | 10. Modular plug (RJ10) |
| 3. Door contact (RJ10) | 7. RS485 control panels (RJ10) | 11. Modular contact (RJ10) |
| 4. SEC/NTC Sensor (option) (RJ10) | 8. RS485 control panels (RJ10) | |

Connecting components to the modular contacts (maximum cable cross-sectional area for RJ10. 0.9mm/ 0.2mm², AWG24)

Unit	Pos	Pin	Comment
Temp.sensor (10kΩ)	1	2-3	Must be NTC type. May also be connected at Position 4.
External switch without LED indication	2	3-4	Both constant and impulse deactivation work.
External switch with LED indication	2	2-3-4	12VDC (maximum 40mA). Tylö external switch, item number: 9090 8045
Door contact without alarm for door status	3	3-4	Of type NO (Normally Open). Tylö door contact, Item No.: 9090 8035.
Door contact with alarm for door status	3	2-3-4	12VDC (max. 40mA)

FRANÇAIS

Description des connecteurs modulaires

Pos 1.	Pos 2.	Pos 3.	Pos 4.	Pos 5.
NTC	Ext sw	Door sw	Bim/NTC	Addon (option)
Pin 1:	Pin 1:	Pin 1:	Pin 1: Bim	
Pin 2: NTC	Pin 2: LED	Pin 2: LED	Pin 2: NTC	
Pin 3: NTC	Pin 3: SW	Pin 3: SW	Pin 3: NTC	
Pin 4:	Pin 4: 12 V	Pin 4: 12 V	Pin 4: Bim	

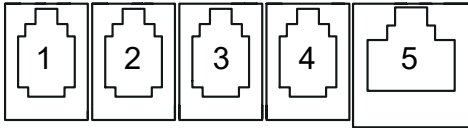

Pos 6-9. 4x RS485

Pin 1: A
Pin 2: B
Pin 3: 12 V
Pin 4: GND

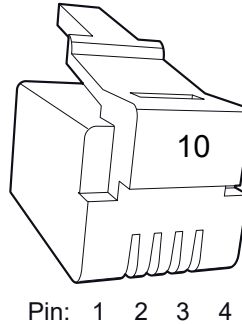
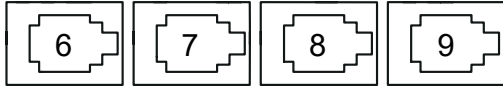

Pin: 1 2 3 4

Pin: 4 3 2 1

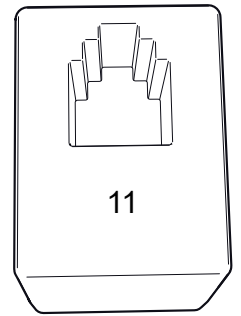

- | | | |
|------------------------------------|--------------------------------------|--------------------------------------|
| 1. Sonde NTC (RJ10) | 5. Extension (au choix) (RJ45) | 9. Panneaux de commande RS485 (RJ10) |
| 2. Interrupteur extérieur (RJ10) | 6. Panneaux de commande RS485 (RJ10) | 10. Prise modulaire (RJ10) |
| 3. Contact de porte (RJ10) | 7. Panneaux de commande RS485 (RJ10) | 11. Contact modulaire (RJ10) |
| 4. Sonde SEC/NTC (au choix) (RJ10) | 8. Panneaux de commande RS485 (RJ10) | |

Raccordement des composants des contacts modulaires (section de câble max. pour RJ10: 0,9 mm/ 0,2 mm², AWG24)

Unité	Pos	Broche	Observations
Sonde de température (10 kΩ)	1	2-3	Doit être de type NTC. Peut aussi se connecter en Pos. 4.
Interrupteur extérieur sans voyant-témoin	2	3-4	Versions à impulsion ou raccordement constant possibles.
Interrupteur extérieur avec voyant-témoin	2	2-3-4	12 V CC (40 mA max.). Interrupteur extérieur TyLö, réf. 9090 8045
Contact de porte sans alarme pour état de porte	3	3-4	De type NO (Normalement ouvert). Contact de porte TyLö, réf. 9090 8035.
Contact de porte avec alarme pour état de porte	3	2-3-4	12 V CC (40 mA max.)

РУССКИЙ

Описание модульного соединителя

Pos 1.	Pos 2.	Pos 3.	Pos 4.	Pos 5.
NTC	Ext sw	Door sw	Bim/NTC	Addon (option)
Pin 1:	Pin 1:	Pin 1:	Pin 1: Bim	
Pin 2: NTC	Pin 2: LED	Pin 2: LED	Pin 2: NTC	
Pin 3: NTC	Pin 3: SW	Pin 3: SW	Pin 3: NTC	
Pin 4:	Pin 4: 12 V	Pin 4: 12 V	Pin 4: Bim	

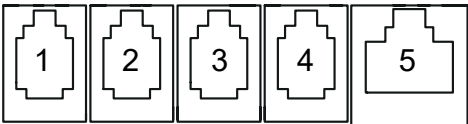

Pos 6-9. 4x RS485

Pin 1: A
Pin 2: B
Pin 3: 12 V
Pin 4: GND

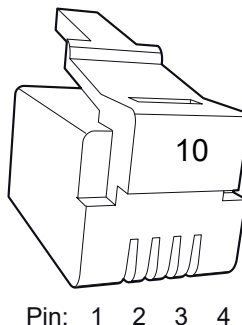
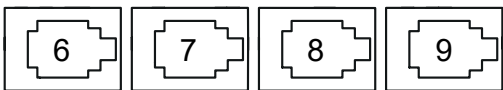

Pin: 1 2 3 4

Pin: 4 3 2 1

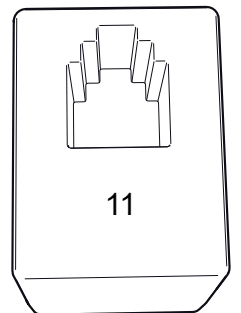

- | | | |
|--|-----------------------------------|-----------------------------------|
| 1. Датчик NTC (RJ10) | 5. Расширение (опционально)(RJ45) | 9. Панели управления RS485 (RJ10) |
| 2. Внешний переключатель (RJ10) | 6. Панели управления RS485 (RJ10) | 10. Модульный штекер (RJ10) |
| 3. Дверной контакт (RJ10) | 7. Панели управления RS485 (RJ10) | 11. Модульный контакт (RJ10) |
| 4. Датчик SEC/NTC (опционально) (RJ10) | 8. Панели управления RS485 (RJ10) | |

Подключение компонентов к модульным контактам (максимальная площадь поперечного сечения кабеля для RJ10. 0,9мм/ 0,2мм², AWG24)

Устройство	Поз.	Штыревой контакт	Примечания
Датчик температуры (10 кОм)	1	2-3	Должен представлять собой датчик типа NTC. Также может подключаться к Позиции 4.
Внешний переключатель без светодиодной индикации	2	3-4	Поддерживается как постоянная, так и импульсная деактивация.
Внешний переключатель со светодиодной индикацией	2	2-3-4	12 В постоянного тока (макс. 40 мА). Внешний переключатель TyLö, арт. №: 9090 8045
Дверной контакт без сигнализации о состоянии двери	3	3-4	Типа NO (Нормально разомкнут). Дверной контакт TyLö, арт. №: 9090 8035.
Дверной контакт с сигнализацией о состоянии двери	3	2-3-4	12 В постоянного тока (макс. 40 мА).

DEUTSCH

Beschreibung des Modularsteckers

Pos 1.	Pos 2.	Pos 3.	Pos 4.	Pos 5.
NTC	Ext sw	Door sw	Bim/NTC	Addon (option)
Pin 1:	Pin 1:	Pin 1:	Pin 1: Bim	
Pin 2: NTC	Pin 2: LED	Pin 2: LED	Pin 2: NTC	
Pin 3: NTC	Pin 3: SW	Pin 3: SW	Pin 3: NTC	
Pin 4:	Pin 4: 12 V	Pin 4: 12 V	Pin 4: Bim	

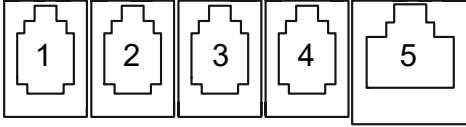

Pos 6-9. 4x RS485

Pin 1: A
Pin 2: B
Pin 3: 12 V
Pin 4: GND

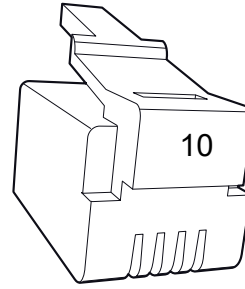
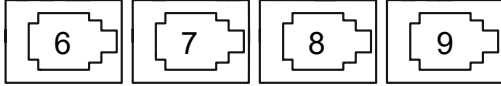

Pin: 1 2 3 4

Pin: 4 3 2 1

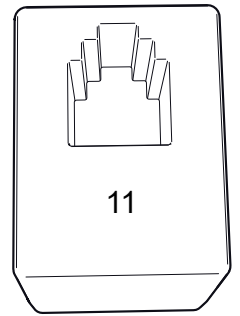

- | | | |
|-------------------------------------|------------------------------|------------------------------|
| 1. NTC-Sensor (RJ10) | 5. Add-On (Option) (RJ45) | 9. RS485-Bedienpanels (RJ10) |
| 2. Externer Schalter (RJ10) | 6. RS485-Bedienpanels (RJ10) | 10. Modularstecker (RJ10) |
| 3. Türkontakt (RJ10) | 7. RS485-Bedienpanels (RJ10) | 11. Modularkontakt (RJ10) |
| 4. SEC/NTC-Sensor (optional) (RJ10) | 8. RS485-Bedienpanels (RJ10) | |

Verbindung von Bauteilen mit den Modularkontakten (max. Kabelquerschnitt für RJ10. 0,9 mm/ 0,2 mm², AWG 24)

Einheit	Pos.	Stift	Kommentar
Temp.sensor (10 kΩ)	1	2-3	Unbedingt vom Typ NTC. Kann auch an Pos. 4 angeschlossen werden.
Externer Schalter ohne LED-Anzeige	2	3-4	Sowohl ständige als auch intermittierende Deaktivierung funktioniert.
Externer Schalter mit LED-Anzeige	2	2-3-4	12 VDC (max. 40 mA). Externer Tylö Schalter, Artikelnr.: 9090 8045
Türkontakt ohne Türstatus-Alarm	3	3-4	Arbeitskontakt. Tylö Türkontakt, Artikelnr.: 9090 8035.
Türkontakt mit Türstatus-Alarm	3	2-3-4	12 VDC (max. 40 mA)

NEDERLANDS

Beschrijving van modulaire connector

Pos 1.	Pos 2.	Pos 3.	Pos 4.	Pos 5.
NTC	Ext sw	Door sw	Bim/NTC	Addon (option)
Pin 1:	Pin 1:	Pin 1:	Pin 1: Bim	
Pin 2: NTC	Pin 2: LED	Pin 2: LED	Pin 2: NTC	
Pin 3: NTC	Pin 3: SW	Pin 3: SW	Pin 3: NTC	
Pin 4:	Pin 4: 12 V	Pin 4: 12 V	Pin 4: Bim	

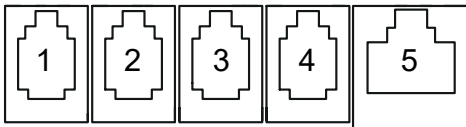

Pos 6-9. 4x RS485

Pin 1: A
Pin 2: B
Pin 3: 12 V
Pin 4: GND

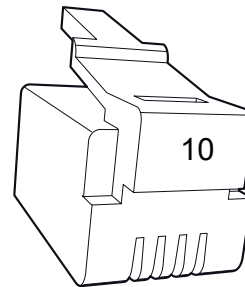
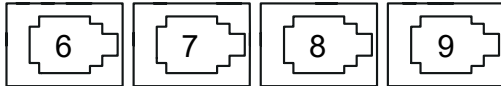

Pin: 1 2 3 4

Pin: 4 3 2 1

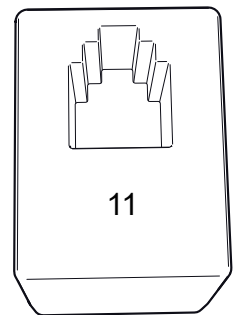

- | | | |
|----------------------------------|---|--------------------------------|
| 1. NTC-sensor (RJ10) | 5. Uitbreiding (optie voor Home) (RJ45) | 9. RS485-bedienspanelen (RJ10) |
| 2. Externe schakelaar (RJ10) | 6. RS485-bedienspanelen (RJ10) | 10. Modulaire stekker (RJ10) |
| 3. Deurcontact (RJ10) | 7. RS485-bedienspanelen (RJ10) | 11. Modulair contact (RJ10) |
| 4. SEC/NTC-sensor (optie) (RJ10) | 8. RS485-bedienspanelen (RJ10) | |

Onderdelen aansluiten op de modulaire contacten (maximale doorsnede van kabel voor RJ10. 0,9 mm/ 0,2 mm², AWG24)

Eenheid	Pos.	Pen	Opmerking
Temp.sensor (10 kΩ)	1	2-3	Moet NTC-type zijn. Mag ook worden aangesloten op positie 4.
Externe schakelaar zonder LED-indicatie	2	3-4	Zowel constante als pulsdeactivering werken.
Externe schakelaar met LED-indicatie	2	2-3-4	12 VDC (maximaal 40 mA). Tylö externe schakelaar, artikelnummer: 9090 8045
Deurcontact zonder alarm voor deurstatus	3	3-4	Van type NO (Normaal Open). Tylö-deurcontact, artikelnr.: 9090 8035.
Deurcontact met alarm voor deurstatus	3	2-3-4	12 VDC (max. 40 mA)

POLSKI

Opis złącza modułowego

Pos 1.	Pos 2.	Pos 3.	Pos 4.	Pos 5.
NTC	Ext sw	Door sw	Bim/NTC	Addon (option)

Pin 1:	Pin 1:	Pin 1:	Pin 1:	Pin 1:
Pin 2: NTC	Pin 2: LED	Pin 2: LED	Pin 2: NTC	
Pin 3: NTC	Pin 3: SW	Pin 3: SW	Pin 3: NTC	
Pin 4:	Pin 4: 12 V	Pin 4: 12 V	Pin 4: Bim	

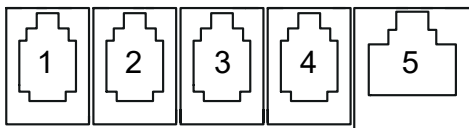

Pos 6-9.
4x RS485

Pin 1: A
Pin 2: B
Pin 3: 12 V
Pin 4: GND

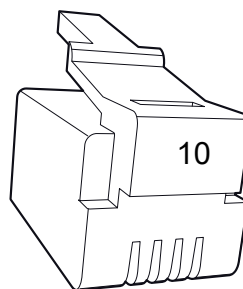
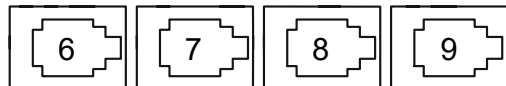

Pin: 1 2 3 4

Pin: 4 3 2 1

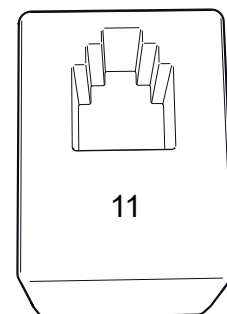

- | | | |
|-----------------------------------|---|-----------------------------------|
| 1. Czujnik NTC (RJ10) | 5. Dodatek – opcja dla urządzeń do użytku domowego (RJ45) | 9. Panele sterowania RS485 (RJ10) |
| 2. Przełącznik zewnętrzny (RJ10) | 6. Panele sterowania RS485 (RJ10) | 10. Wtyk modularny (RJ10) |
| 3. Styk drzwiowy (RJ10) | 7. Panele sterowania RS485 (RJ10) | 11. Styk modularny (RJ10) |
| 4. Czujnik SEC/NTC (opcja) (RJ10) | 8. Panele sterowania RS485 (RJ10) | |

Podłączanie komponentów do kontaktów modułowych (maksymalny przekrój kabla RJ10; 0,9 mm/0,2 mm², AWG24)

Jednostka	Poz.	Styk	Uwaga
Czujnik temp. (10 kΩ)	1	2-3	Musi być typu NTC. Może być także podłączony w pozycji 4.
Przełącznik zewnętrzny bez wskaźnika LED	2	3-4	Działa zarówno stała, jak i impulsowa dezaktywacja.
Przełącznik zewnętrzny ze wskaźnikiem LED	2	2-3-4	12 VDC (maks. 40 mA); przełącznik zewnętrzny Tylö, numer elementu: 9090 8045
Styk drzwiowy bez alarmu stanu drzwi	3	3-4	Typu NO (normalnie otwarty). Styk drzwiowy Tylö, numer elementu: 9090 8035.
Styk drzwiowy z alarmem stanu drzwi	3	2-3-4	12 VDC (maks. 40 mA)